



Testing Laboratory 1045.1 accredited by the Czech Accreditation Institute pursuant to  
ČSN EN ISO/IEC 17025:2018

**Strojírenský zkušební ústav, s.p. Zkušební laboratoř**  
**(Engineering Test Institute, Public Enterprise, Testing Laboratory)**  
**Hudcova 424/56b, Medlánky, 621 00 Brno**

Page 1 of 33



## **TEST REPORT**

### **39-17758/T**

**Product:** Outdoor Air/Water Heat pump - monobloc

**Type designation:** TAHMV12S A

**Customer:** Guangdong Tongyi Heat Pump Science and Technology Corp.  
Room 2001-2010, 20/F, No.159 Middle Qiaozhong Road  
510163 Liwan District, Guangzhou  
CHINA

**Manufacturer:** Guangdong Tongyi Heat Pump Science and Technology Corp.  
Room 2001-2010, 20/F, No.159 Middle Qiaozhong Road  
510163 Liwan District, Guangzhou  
CHINA

**Report issue date:** 2024-07-18

**Distribution list:** 1 copy to the Customer  
1 copy to the Engineering Test Institute

This document may be copied in its entirety without written consent of the Engineering Test Institute. Partial copies are subject to approval. The results of the tests and verifications shall relate only to the products tested as received or presented. The testing laboratory is not responsible for the data provided by the customer specified in the report.

SP-2021-000012\_1\_12

## I. Description of product tested

The Heat pump **TAH MV12S A** supplied by the company **Guangdong Tongyi Heat Pump Science and Technology Corp.** is structurally adapted to operate in air/water system. Device is designed as monobloc placed outdoor. Refrigerant R32 is used with charge 2.2 kg. Power supply is a three-phase. Heat pump is able to work in heating and cooling mode. Heat pump is working with fixed flow rate.

Main components of the outdoor unit **TAH MV12S A**:

- Serial number NETAH MV12SBWY12SX000288
- Cuboid shape with dimensions 1260 × 425 × 865 mm (W × D × H)
- Frame and casing made of varnished steel sheets
- L-shaped evaporator, 3 rows, dimensions 840 × 20 × 1140 mm (W × D × H), spacing 2 mm
- Plate condenser, dimensions 70 × 30 × 310 mm (W × D × H) including insulation
- Plate condenser, dimensions 140 × 140 × 340 mm (W × D × H) including insulation
- Compressor Panasonic 9KD420ZAA2J
- Refrigerant R32 (2.2 kg)
- Refrigerant accumulator
- Axial fan Ø560 mm
- DC motor ZSFN-310-8-85F
- Circulation pump SHIMGE
- Paddle flow switch ACOL
- Expansion tank 2L ACOL
- Pressure sensors
- Temperature sensors
- Refrigerant pipes

Scheme:

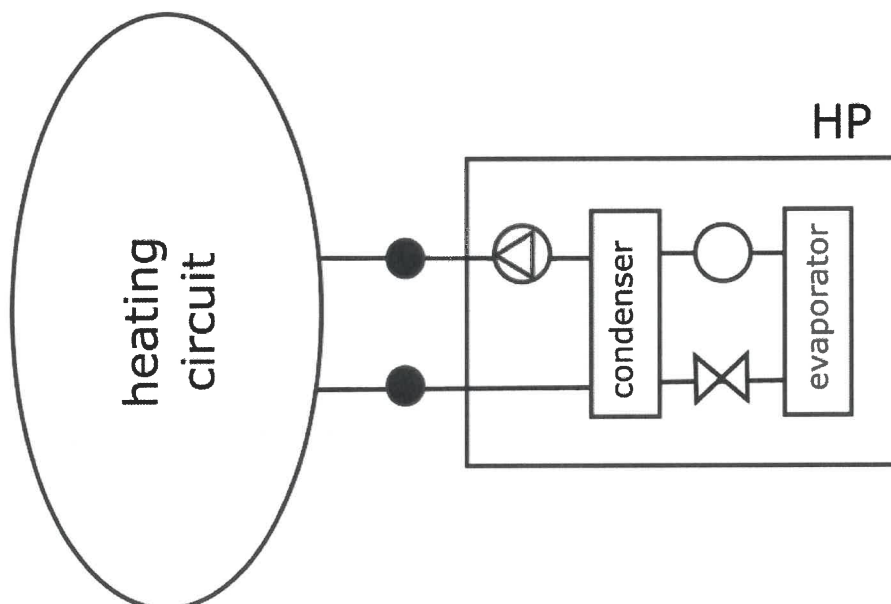

Photodocumentation:



Heat pump TAHMV12S A – outdoor unit  
– Front view –

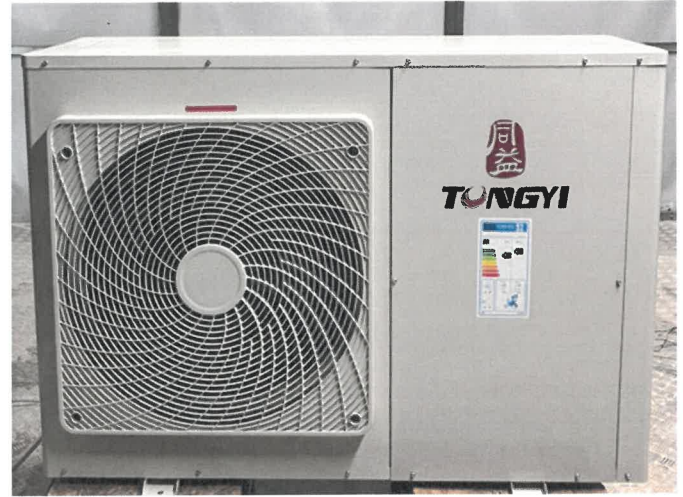

Heat pump TAHMV12S A – outdoor unit  
– Back view –

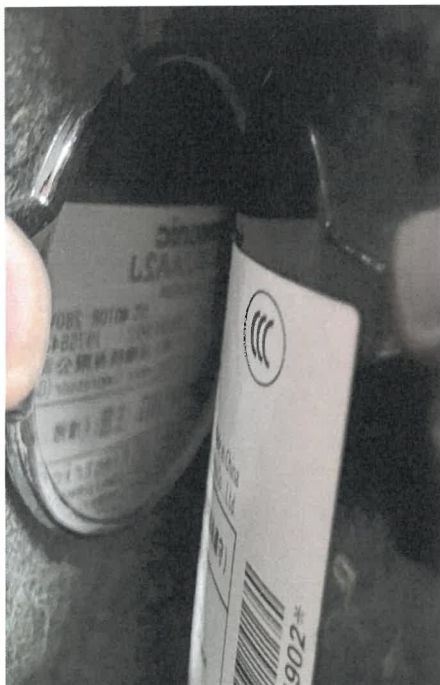

Heat pump TAHMV12S A – outdoor unit  
– Compressor label –

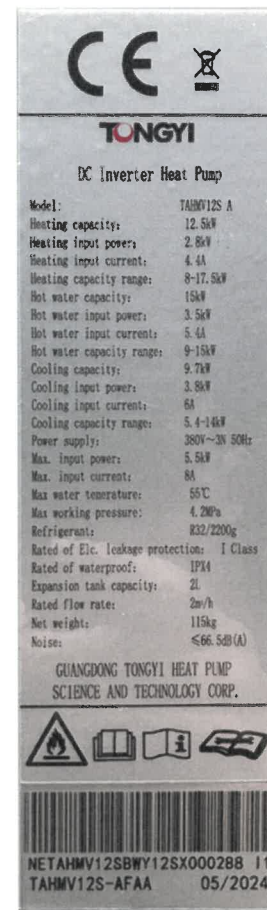

Heat pump TAHMV12S A – outdoor unit  
– Label –

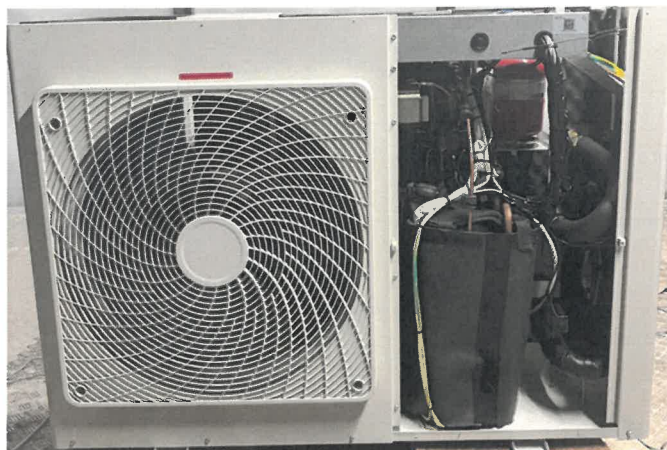

Heat pump TAHMV12S A – outdoor unit  
 – Without cover –

## II. Sample tested

SZU reg. no.	Product name	Date of submission
1212.24.40194.001	TAHMV12S	2024-06-19

The visual inspection, tests and verification were carried out by Ing. Alexandr Jordanov and Ing. Dominik Šedivý, Ph.D. at the test station of SZU.

The tests were performed using measuring and testing equipment with valid calibration.

## III. Measuring and test equipment:

No.	Description	Inventory number
1.	Electrical energy meter	022370/1
2.	Digital watt meter	MaR01/EM01
3.	Flow meter Krohne Optiflux	022370/5
4.	Barometer	022370/7
5.	Differential pressure gauge	MaR01_TI
6.	Temperature-humidity meter HC2-IC305	022370/10
7.	Temperature-humidity meter HC2-IC305	022370/11 022370/12
8.	Thermometers	022370/13

**IV. Methods, results of tests and verifications**

No.	Test objective	Requirement	Method of test	Documentation	Test evaluation/ verification *
1.	Rating conditions	-	ČSN EN 14511-2:2023 ČSN EN 14511-3:2023	Page No. 6	x
2.	Seasonal performance tests and SCOP calculation – Low temperature application	-	ČSN EN 14511-3:2023 ČSN EN 14825:2023	Page No. 7-13	x
3.	Seasonal performance tests and SCOP calculation – Medium temperature application	-	ČSN EN 14511-3:2023 ČSN EN 14825:2023	Page No. 14-20	x
<b>*) Evaluation / statement of conformity:</b>					
+..... Requirement fulfilled			0 .....Not applicable		
-..... Requirement not fulfilled			x .....Not evaluated		

**Note:**

The stated extended measurement uncertainties are calculated as a factor of the measurement uncertainty and the extension coefficient  $k=2$ , corresponding to the coverage certainty of 95% as regards standard classification.

If a statement of conformity is provided, the decision rule pursuant to ILAC-G8:09/2019, Art. 4.2.1 - binary statement for the simple acceptance rule shall apply.

<b>Test objective:</b>	Rating conditions
<b>Exact name of the test procedure:</b>	<b>1.37 - Tests of leakage, pressure resistance, thermal and technical parameters, combustion efficiency, safety functions</b>
<b>Test method:</b>	ČSN EN 14511-2:2023, ČSN EN 14511-3:2023
<b>Sample tested:</b>	Heat pump TAHMV12S A
<b>Measuring equipment used:</b>	see Chapter III

Specification of the assessment condition		<b>A7/W35</b>	<b>A7/W55</b>
Date of testing		<b>2024-07-09</b>	<b>2024-07-09</b>
Transient test procedure	YES / NO	NO	NO
Average defrost time of 1 cycle	[min]	–	–
Average time of 1 cycle	[min]	–	–
Calculation time	[min]	70.0	70.0
Output heating water – temperature calculation	[°C]	34.98	55.03
Input heating water – temperature calculation	[°C]	29.93	46.98
Output heating water temperature	[°C]	34.98	55.03
Input heating water temperature	[°C]	29.93	46.98
Air temperature – dry bulb temperature	[°C]	6.89	6.93
Air temperature – wet bulb temperature	[°C]	5.83	5.88
Relative humidity	[%]	86.03	86.06
Barometric pressure	[kPa]	98.782	98.627
Ambient temperature	[°C]	7.14	7.23
Secondary circuit pressure difference	[kPa]	98.425	98.374
Efficiency of the secondary liquid pump	[-]	0.441	0.437
Volume flow rate of heating water	[m <sup>3</sup> ·h <sup>-1</sup> ]	2.0634	1.2744
Density of heating water	[kg·m <sup>-3</sup> ]	994.0	985.8
Specific heat capacity of heating water	[kJ·kg <sup>-1</sup> ·K <sup>-1</sup> ]	4.175	4.179
Voltage	[V]	399.41	398.99
Total current	[A]	12.76	17.94
Overall power input	[kW]	2.542	3.759
Capacity correction of sec. liquid pump	[W]	62.61	58.17
Power input correction of sec. liquid pump	[W]	95.51	87.45
Heating capacity – heating water	[kW]	11.996	11.779
<b>Corrected heating capacity – heating water</b>	<b>[kW]</b>	<b>11.933</b>	<b>11.721</b>
Uncertainty of corrected heating capacity	[kW]	± 0.203	± 0.126
<b>Effective electric power input</b>	<b>[kW]</b>	<b>2.446</b>	<b>3.672</b>
<b>COP</b>	<b>[-]</b>	<b>4.878</b>	<b>3.192</b>
Uncertainty of COP	[-]	± 0.085	± 0.035
<b>Control settings</b>	<b>[Hz]</b>	<b>45</b>	<b>42</b>
Circulation pump settings – heating water	[%]	100	100

<b>Test objective:</b>	Seasonal performance tests and SCOP calculation – Low temperature application
<b>Exact name of the test procedure:</b>	<b>1.37 - Tests of leakage, pressure resistance, thermal and technical parameters, combustion efficiency, safety functions</b>
<b>Test method:</b>	ČSN EN 14511-3:2023, ČSN EN 14825:2023
<b>Sample tested:</b>	Heat pump TAHMV12S A
<b>Measuring equipment used:</b>	see Chapter III

Design		Air / water – monobloc			
Conditions specification according to ČSN EN 14825:2023	to EN	Temperature application			Low (reference water temperature 35 °C)
		Reference heating season			Average
		Outlet water temperature - indoor heat exchanger			Variable
		Compressor speed control			Variable
		Water flow rate – primary circuit			–
		Water flow rate – secondary circuit			Fixed
Seasonal heating efficiency	space energy	Heating	Average	$\eta_s$	183.2 %
			Warmer	$\eta_s$	– %
			Colder	$\eta_s$	– %
Seasonal efficiency according to ČSN EN 14825:2023	EN	Heating	Average	SCOP	4.66 –
			Warmer	SCOP	– –
			Colder	SCOP	– –
Function	Cooling				Yes
	Heating	Yes	Reference heating season	Average	Yes
				Warmer	–
				Colder	–
Full heating load	Cooling		$P_{designc}$		– kW
	Heating	Average	$P_{designh}$		10.20 kW
		Warmer	$P_{designh}$		– kW
		Colder	$P_{designh}$		– kW
Bivalent temperatures	Heating	Average	$T_{bivalent}$		-7 °C
		Warmer	$T_{bivalent}$		– °C
		Colder	$T_{bivalent}$		– °C
Operation temperatures limit	Heating	Average	TOL		-10 °C
		Warmer	TOL		– °C
		Colder	TOL		– °C
Seasonal consumption according to ČSN EN 14825:2023	power to	Cooling		$Q_{CE}$	– kWh
		Heating	Average	$Q_{HE}$	4524 kWh
			Warmer	$Q_{HE}$	– kWh
			Colder	$Q_{HE}$	– kWh
Modes other than „active mode“	Off mode		$P_{OFF}$	52.4 W	
	Thermostat off mode		$P_{TO}$	53.7 W	
	Standby mode		$P_{SB}$	52.4 W	
	Crankcase heater mode		$P_{CK}$	0.0 W	

### Calculation of SCOP according to ČSN EN 14825:2023:

Number of hours used for calculation of reference SCOP (Annex B – Table B. 2, B. 3)

- For reversible heat pumps and reference heating season „A“ = average

H <sub>HE</sub>	2066	[h]
H <sub>TO</sub>	178	[h]
H <sub>SB</sub>	0	[h]
H <sub>CK</sub>	178	[h]
H <sub>OFF</sub>	0	[h]

Measured data:

P <sub>TO</sub>	0.0537	[kW]
P <sub>SB</sub>	0.0524	[kW]
P <sub>CK</sub>	0.0000	[kW]
P <sub>OFF</sub>	0.0524	[kW]
P <sub>designh</sub>	10.20	[kW]
SCOP <sub>ON</sub>	4.67	[-]

Coefficient and correction:

F(1)	3	[%]
F(2)	0	[%]
CC	2.5	[-]

#### Calculation of SCOP:

7.3 Calculation of the reference annual heating demand (Q<sub>H</sub>)

$$Q_H = P_{\text{designh}} \cdot H_{HE} \quad [\text{kWh}]$$

$$Q_H = 10.20 \cdot 2066 = \mathbf{21065} \quad [\text{kWh}]$$

7.4 Calculation of the annual electricity consumption (Q<sub>HE</sub>)

$$Q_{HE} = Q_H / \text{SCOP}_{\text{on}} + H_{TO} \cdot P_{TO} + H_{SB} \cdot P_{SB} + H_{CK} \cdot P_{CK} + H_{\text{OFF}} \cdot P_{\text{OFF}} \quad [\text{kWh}]$$

$$Q_{HE} = 21065 / 4.67 + 178 \cdot 0.0537 + 0 \cdot 0.0524 + 178 \cdot 0 + 0 \cdot 0.0524 = \mathbf{4524} \quad [\text{kWh}]$$

7.2 General formula for calculation of reference SCOP

$$\text{SCOP} = Q_H / Q_{HE} \quad [-]$$

$$\text{SCOP} = 21065 / 4524 = \mathbf{4.66} \quad [-]$$

7.1 Calculation of the seasonal space heating efficiency  $\eta_s$

$$\Sigma F(i) = F(1) + F(2) \quad [-]$$

$$\Sigma F = 0.03 + 0 = 0.03 \quad [-]$$

$$\eta_s = 1 / \text{CC} \cdot \text{SCOP} - \Sigma F(i) \quad [-]$$

$$\eta_s (A) = (1 / 2.5) \cdot 4.66 - 0.03 = \mathbf{1.832} \quad [-]$$



Temperature level		Low (reference water temperature 35 °C)		
Reference heating season		„A“ = average ( $T_{\text{designh}} = -10 \text{ °C}$ )		
Assessment condition		B	C	D
Specification of the assessment condition		A2/W30	A7/W28.24	A12/W26.48
Date of testing		2024-07-10	2024-07-10	2024-07-16
Transient test procedure	YES / NO	NO	NO	NO
Average defrost time of 1 cycle	[min]	–	–	–
Average time of 1 cycle	[min]	–	–	–
Calculation time	[min]	70.0	70.0	70.0
Output heating water – temperature calculation	[°C]	29.97	28.25	26.48
Input heating water – temperature calculation	[°C]	27.57	25.49	23.30
Output heating water temperature	[°C]	29.97	28.25	26.48
Input heating water temperature	[°C]	27.57	25.49	23.30
Air temperature – dry bulb temperature	[°C]	2.05	7.03	11.89
Air temperature – wet bulb temperature	[°C]	1.00	5.95	10.82
Relative humidity	[%]	83.06	85.77	88.12
Barometric pressure	[kPa]	98.441	98.306	98.147
Ambient temperature	[°C]	1.93	7.09	11.98
Secondary circuit pressure difference	[kPa]	60.236	59.882	57.087
Efficiency of the secondary liquid pump	[-]	0.348	0.348	0.344
Volume flow rate of heating water	[m <sup>3</sup> ·h <sup>-1</sup> ]	2.0551	2.0603	2.0550
Density of heating water	[kg·m <sup>-3</sup> ]	995.5	996.0	996.5
Specific heat capacity of heating water	[kJ·kg <sup>-1</sup> ·K <sup>-1</sup> ]	4.176	4.176	4.177
Voltage	[V]	399.72	399.93	399.65
Total current	[A]	6.99	6.78	5.90
Overall power input	[kW]	1.297	1.194	1.064
Capacity correction of sec. liquid pump	[W]	64.425	64.284	62.219
Power input correction of sec. liquid pump	[W]	98.81	98.55	94.81
Heating capacity – heating water	[kW]	5.685	6.554	7.552
<b>Corrected heating capacity – heating water</b>	<b>[kW]</b>	<b>5.620</b>	<b>6.489</b>	<b>7.490</b>
Uncertainty of corrected heating capacity	[kW]	± 0.202	± 0.202	± 0.202
<b>Effective electric power input</b>	<b>[kW]</b>	<b>1.198</b>	<b>1.095</b>	<b>0.969</b>
<b>COP</b>	<b>[-]</b>	<b>4.692</b>	<b>5.925</b>	<b>7.727</b>
Uncertainty of COP	[-]	± 0.169	± 0.186	± 0.210
<b>Control settings</b>	<b>[Hz]</b>	<b>25</b>	<b>25</b>	<b>25</b>
Circulation pump settings – heating water	[%]	100	100	100

Temperature level		Low (reference water temperature 35 °C)	
Reference heating season		„A“ = average ( $T_{designh} = -10\text{ °C}$ )	
Assessment condition		<b>TOL(E)</b>	<b>A, T<sub>biv</sub>(F)</b>
Specification of the assessment condition		<b>A-10/W35</b>	<b>A-7/W34</b>
Date of testing		<b>2024-07-16</b>	<b>2024-07-10</b>
Transient test procedure	YES / NO	NO	YES
Average defrost time of 1 cycle	[min]	–	5.6
Average time of 1 cycle	[min]	–	105.3
Calculation time	[min]	70.0	105.3
Output heating water – temperature calculation	[°C]	35.01	33.19
Input heating water – temperature calculation	[°C]	30.93	29.36
Output heating water temperature	[°C]	35.01	34.03
Input heating water temperature	[°C]	30.93	29.64
Air temperature – dry bulb temperature	[°C]	-9.98	-7.15
Air temperature – wet bulb temperature	[°C]	-10.96	-8.15
Relative humidity	[%]	68.99	73.73
Barometric pressure	[kPa]	98.078	98.551
Ambient temperature	[°C]	-10.26	-6.85
Secondary circuit pressure difference	[kPa]	57.777	60.427
Efficiency of the secondary liquid pump	[-]	0.345	0.348
Volume flow rate of heating water	[m <sup>3</sup> ·h <sup>-1</sup> ]	2.0544	2.0536
Density of heating water	[kg·m <sup>-3</sup> ]	994.0	994.5
Specific heat capacity of heating water	[kJ·kg <sup>-1</sup> ·K <sup>-1</sup> ]	4.175	4.175
Voltage	[V]	399.05	399.05
Total current	[A]	15.31	15.01
Overall power input	[kW]	3.162	3.090
Capacity correction of sec. liquid pump	[W]	62.691	64.530
Power input correction of sec. liquid pump	[W]	95.66	99.00
Heating capacity – heating water	[kW]	9.651	9.084
<b>Corrected heating capacity – heating water</b>	<b>[kW]</b>	<b>9.589</b>	<b>9.020</b>
Uncertainty of corrected heating capacity	[kW]	± 0.202	± 0.202
<b>Effective electric power input</b>	<b>[kW]</b>	<b>3.067</b>	<b>2.991</b>
<b>COP</b>	<b>[-]</b>	<b>3.127</b>	<b>3.015</b>
Uncertainty of COP	[-]	± 0.066	± 0.068
<b>Control settings</b>	<b>[Hz]</b>	<b>56</b>	<b>56</b>
Circulation pump settings – heating water	[%]	100	100

**Data for SCOP calculation**

- Low temperature application (reference water temperature 35 °C)
- Reference heating season „A“ – average

	Outdoor heat exchanger	Indoor heat exchanger	Part load ratio	Part load	DC Declared capacity	COPd at declared capacity	Cdh degradation coefficient	CR	COPbin (Tj)	Eff. power input of compressor off state
	Outdoor air inlet	Outlet water temperature								
	[°C]	[°C]								
<b>A</b>	-7	34.00	88.46	9.02	9.020	3.015	0.900	1.00	3.015	–
<b>B</b>	2	30.00	53.85	5.49	5.620	4.692	0.900	1.00	4.692	–
<b>C</b>	7	28.24	34.62	3.53	6.496	5.925	0.951	0.45	5.690	0.0537
<b>D</b>	12	26.48	15.38	1.57	7.490	7.727	0.945	0.21	6.391	0.0537
<b>TOL (E)</b>	-10	35.00	100.00	10.20	9.589	3.127	0.900	1.00	3.127	–
<b>Tbiv (F)</b>	-7	34.00	88.46	9.02	9.020	3.015	0.900	1.00	3.015	–

**Adaption of water temperature – according to ČSN EN 14825:2023, Annex E**

- Low temperature application (reference water temperature 35 °C)
- Reference season „A“ – average
- Condition D
- Fixed water flow rate – secondary circuit

General formulas and derivation:

$$\begin{aligned} \dot{t}_{\text{outlet, average}} &= \dot{t}_{\text{inlet, capacity test}} + (\dot{t}_{\text{outlet, capacity test}} - \dot{t}_{\text{inlet, capacity test}}) \cdot CR && [^{\circ}\text{C}] \\ \dot{t}_{\text{outlet, average}} &= \dot{t}_{\text{inlet, capacity test}} + (\Delta t) \cdot CR && [^{\circ}\text{C}] \\ \dot{t}_{\text{outlet, average}} &= \dot{t}_{\text{outlet, capacity test}} - \Delta t + \Delta t \cdot CR && [^{\circ}\text{C}] \\ \dot{t}_{\text{outlet, capacity test}} &= \dot{t}_{\text{outlet, average}} + \Delta t - \Delta t \cdot CR && [^{\circ}\text{C}] \end{aligned}$$

For fixed flow:

$$\Delta t = \text{Declared capacity} / \text{Declared capacity}_{\text{standard rating conditions A7W35}} \cdot 5$$

$$CR \cdot \Delta t = \text{Part load} / \text{Declared capacity} \cdot \text{Declared capacity} / \text{Declared capacity}_{\text{standard rating conditions A7W35}} \cdot 5$$

$$CR \cdot \Delta t = \text{Part load} / \text{Declared capacity}_{\text{standard rating conditions A7W35}} \cdot 5$$

$$\dot{t}_{\text{outlet, capacity test, fixed flow}} = \dot{t}_{\text{outlet, average}} + \text{Declared capacity} / \text{Declared capacity}_{\text{standard rating conditions A7W35}} \cdot 5 - \text{Part load} / \text{Declared capacity}_{\text{standard rating conditions A7W35}} \cdot 5$$

$$\dot{t}_{\text{outlet, capacity test, fixed flow}} = \dot{t}_{\text{outlet, average}} + 5 / \text{Declared capacity}_{\text{standard rating conditions A7W35}} \cdot (\text{Declared capacity} - \text{Part load})$$

Measured data:

$\dot{t}_{\text{outlet, average}}$	24.00	[°C]
Declared capacity	7.490	[kW]
Declared capacity <sub>standard rating condition A7/W35</sub>	11.933	[kW]
Part load	1.57	[kW]

**Calculation of water temperature**

$$t_{\text{outlet, capacity test, fixed flow}} = 24 + 5 / 11.933 \cdot (7.490 - 1.570) = \underline{\underline{26.48}} \quad [^{\circ}\text{C}]$$

**Calculation SCOP, SCOP<sub>on</sub>, SCOP<sub>net</sub>**

- Low temperature application (reference water temperature 35 °C)
- Reference heating season „A“ – average

Bin	Outdoor temp. (dry bulb)	Hours	Part load ratio	Heat load	Capacity of HP	Heat load covered by heat pump	Resistive heat elbu (Tj)	Annual resistive heat	COPbin (Tj)	Annual heating demand	Annual power input including electric back up heating	Net annual heating capacity	Net annual power input without electric back up heating	
j	Tj	hj		Ph(Tj)			elbu(Tj)	hj x elbu(Tj)	COPbin in (Tj)	hj x Ph(Tj)		hj x (Ph(Tj) - elbu(Tj))		
[-]	[°C]	[h]	[%]	[kW]	[kW]	[kW]	[kW]	[kWh]	[-]	[kWh]	[kWh]	[kWh]	[kWh]	
<b>TOL(E)</b>	<b>21</b>	<b>-10</b>	<b>1</b>	<b>100.00</b>	<b>10.20</b>	<b>9.59</b>	<b>9.59</b>	<b>0.61</b>	<b>0.61</b>	<b>3.13</b>	<b>10</b>	<b>4</b>	<b>10</b>	<b>3</b>
	22	-9	25	96.15	9.80	9.40	9.40	0.40	10.12	3.09	245	86	235	76
	23	-8	23	92.31	9.41	9.21	9.21	0.20	4.66	3.05	216	74	212	69
<b>A, Tbiv (F)</b>	<b>24</b>	<b>-7</b>	<b>24</b>	<b>88.46</b>	<b>9.02</b>	<b>9.02</b>	<b>9.02</b>	<b>0.00</b>	<b>0.00</b>	<b>3.02</b>	<b>216</b>	<b>72</b>	<b>216</b>	<b>72</b>
	25	-6	27	84.62	8.63	8.64	8.63	0.00	0.00	3.20	233	73	233	73
	26	-5	68	80.77	8.24	8.26	8.24	0.00	0.00	3.39	560	165	560	165
	27	-4	91	76.92	7.84	7.89	7.84	0.00	0.00	3.57	714	200	714	200
	28	-3	89	73.08	7.45	7.51	7.45	0.00	0.00	3.76	663	176	663	176
	29	-2	165	69.23	7.06	7.13	7.06	0.00	0.00	3.95	1165	295	1165	295
	30	-1	173	65.38	6.67	6.75	6.67	0.00	0.00	4.13	1153	279	1153	279
	31	0	240	61.54	6.27	6.38	6.27	0.00	0.00	4.32	1506	349	1506	349
	32	1	280	57.69	5.88	6.00	5.88	0.00	0.00	4.51	1647	366	1647	366
<b>B</b>	<b>33</b>	<b>2</b>	<b>320</b>	<b>53.85</b>	<b>5.49</b>	<b>5.62</b>	<b>5.49</b>	<b>0.00</b>	<b>0.00</b>	<b>4.69</b>	<b>1757</b>	<b>374</b>	<b>1757</b>	<b>374</b>
	34	3	357	50.00	5.10	5.80	5.10	0.00	0.00	4.89	1820	372	1820	372
	35	4	356	46.15	4.71	5.97	4.71	0.00	0.00	5.09	1675	329	1675	329
	36	5	303	42.31	4.31	6.15	4.31	0.00	0.00	5.29	1307	247	1307	247
	37	6	330	38.46	3.92	6.32	3.92	0.00	0.00	5.49	1294	236	1294	236
<b>C</b>	<b>38</b>	<b>7</b>	<b>326</b>	<b>34.62</b>	<b>3.53</b>	<b>6.50</b>	<b>3.53</b>	<b>0.00</b>	<b>0.00</b>	<b>5.69</b>	<b>1151</b>	<b>202</b>	<b>1151</b>	<b>202</b>
	39	8	348	30.77	3.14	6.70	3.14	0.00	0.00	5.83	1092	187	1092	187
	40	9	335	26.92	2.75	6.89	2.75	0.00	0.00	5.97	920	154	920	154
	41	10	315	23.08	2.35	7.09	2.35	0.00	0.00	6.11	741	121	741	121
	42	11	215	19.23	1.96	7.29	1.96	0.00	0.00	6.25	422	67	422	67
<b>D</b>	<b>43</b>	<b>12</b>	<b>169</b>	<b>15.38</b>	<b>1.57</b>	<b>7.49</b>	<b>1.57</b>	<b>0.00</b>	<b>0.00</b>	<b>6.39</b>	<b>265</b>	<b>41</b>	<b>265</b>	<b>41</b>
	44	13	151	11.54	1.18	7.69	1.18	0.00	0.00	6.53	178	27	178	27
	45	14	105	7.69	0.78	7.89	0.78	0.00	0.00	6.67	82	12	82	12
	46	15	74	3.85	0.39	8.09	0.39	0.00	0.00	6.81	29	4	29	4
	<b>Σ</b>		<b>4910</b>							<b>Σ</b>	<b>21061</b>	<b>4514</b>	<b>21046</b>	<b>4498</b>

SCOP <sub>on</sub>	4.67	SCOP <sub>net</sub>	4.68
		<b>SCOP</b>	<b>4.66</b>

Part load performance diagram

- Low temperature application (reference water temperature 35 °C)
- Reference heating season „A“ – average

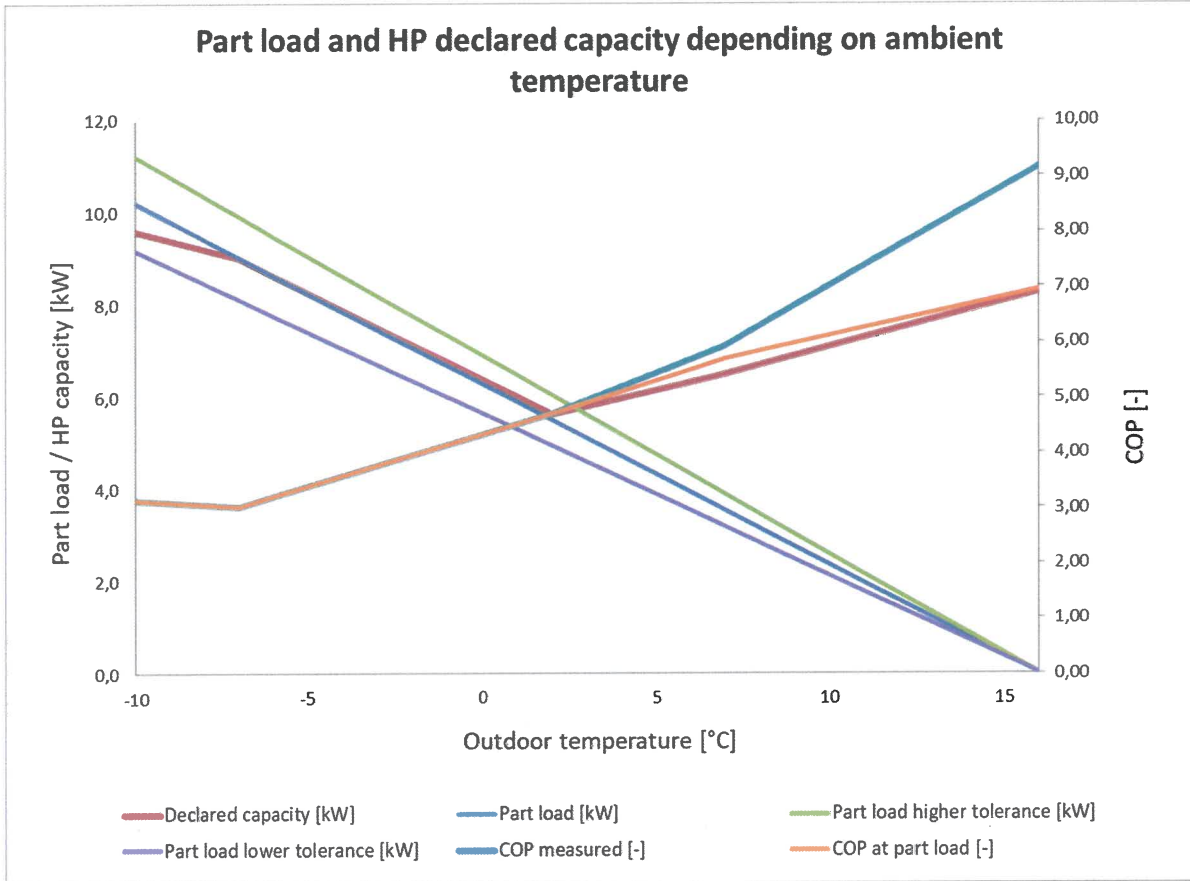

<b>Test objective:</b>	Seasonal performance tests and SCOP calculation – Medium temperature application
<b>Exact name of the test procedure:</b>	<b>1.37 - Tests of leakage, pressure resistance, thermal and technical parameters, combustion efficiency, safety functions</b>
<b>Test method:</b>	ČSN EN 14511-3:2023, ČSN EN 14825:2023
<b>Sample tested:</b>	Heat pump TAHMV12S A
<b>Measuring equipment used:</b>	see Chapter III

Design		Air / water – monobloc				
Conditions specification according to ČSN 14825:2023	to EN	Temperature application			Medium (reference water temperature 55 °C)	
		Reference heating season			Average	
		Outlet water temperature - indoor heat exchanger			Variable	
		Compressor speed control			Variable	
		Water flow rate – primary circuit			–	
		Water flow rate – secondary circuit			Fixed	
Seasonal heating efficiency	space energy	Heating	Average	$\eta_s$	138.6	%
			Warmer	$\eta_s$	–	%
			Colder	$\eta_s$	–	%
Seasonal efficiency according to ČSN 14825:2023	EN	Heating	Average	SCOP	3.54	–
			Warmer	SCOP	–	–
			Colder	SCOP	–	–
Function	Cooling				Yes	
	Heating	Yes	Reference heating season	Average	Yes	
				Warmer	–	
				Colder	–	
Full heating load	Cooling		$P_{designc}$		–	kW
	Heating	Average	$P_{designh}$		10.96	kW
		Warmer	$P_{designh}$		–	kW
		Colder	$P_{designh}$		–	kW
Bivalent temperatures	Heating	Average	$T_{bivalent}$		-7	°C
		Warmer	$T_{bivalent}$		–	°C
		Colder	$T_{bivalent}$		–	°C
Operation temperatures limit	Heating	Average	TOL		-10	°C
		Warmer	TOL		–	°C
		Colder	TOL		–	°C
Seasonal consumption according to ČSN EN 14825:2023	power to	Cooling		$Q_{CE}$	–	kWh
		Heating	Average	$Q_{HE}$		6406
	Warmer		$Q_{HE}$		–	kWh
	Colder		$Q_{HE}$		–	kWh
Modes other than „active mode“	Off mode			$P_{OFF}$	52.4	W
	Thermostat off mode			$P_{TO}$	54.0	W
	Standby mode			$P_{SB}$	52.4	W
	Crankcase heater mode			$P_{CK}$	0.0	W

**Calculation of SCOP according to ČSN EN 14825:2023:**

Number of hours used for calculation of reference SCOP (Annex B – Table B. 2, B. 3)

- For reversible heat pumps and reference heating season „A“ = average

H <sub>HE</sub>	2066	[h]
H <sub>TO</sub>	178	[h]
H <sub>SB</sub>	0	[h]
H <sub>CK</sub>	178	[h]
H <sub>OFF</sub>	0	[h]

Measured data:

P <sub>TO</sub>	0.0540	[kW]
P <sub>SB</sub>	0.0524	[kW]
P <sub>CK</sub>	0.0000	[kW]
P <sub>OFF</sub>	0.0524	[kW]
P <sub>designh</sub>	10.96	[kW]
SCOP <sub>ON</sub>	3.54	[-]

Coefficient and correction:

F(1)	3	[%]
F(2)	0	[%]
CC	2.5	[-]

Calculation of SCOP:

 7.3 Calculation of the reference annual heating demand (Q<sub>H</sub>)

$$Q_H = P_{\text{designh}} \cdot H_{HE} \quad [\text{kWh}]$$

$$Q_H = 10.96 \cdot 2066 = \mathbf{22643} \quad [\text{kWh}]$$

 7.4 Calculation of the annual electricity consumption (Q<sub>HE</sub>)

$$Q_{HE} = Q_H / \text{SCOP}_{\text{on}} + H_{TO} \cdot P_{TO} + H_{SB} \cdot P_{SB} + H_{CK} \cdot P_{CK} + H_{OFF} \cdot P_{OFF} \quad [\text{kWh}]$$

$$Q_{HE} = 22643 / 3.54 + 178 \cdot 0.0540 + 0 \cdot 0.0524 + 178 \cdot 0 + 0 \cdot 0.0524 = \mathbf{6406} \quad [\text{kWh}]$$

7.2 General formula for calculation of reference SCOP

$$\text{SCOP} = Q_H / Q_{HE} \quad [-]$$

$$\text{SCOP} = 22643 / 6406 = \mathbf{3.54} \quad [-]$$

 7.1 Calculation of the seasonal space heating efficiency  $\eta_s$ 

$$\Sigma F(i) = F(1) + F(2) \quad [-]$$

$$\Sigma F = 0.03 + 0 = 0.03 \quad [-]$$

$$\eta_s = 1 / \text{CC} \cdot \text{SCOP} - \Sigma F(i) \quad [-]$$

$$\eta_s (A) = (1 / 2.5) \cdot 3.54 - 0.03 = \mathbf{1.386} \quad [-]$$

Temperature level		Medium (reference water temperature 55 °C)		
Reference heating season		„A“ = average ( $T_{\text{designh}} = -10 \text{ °C}$ )		
Assessment condition		<b>B</b>	<b>C</b>	<b>D</b>
Specification of the assessment condition		<b>A2/W42</b>	<b>A7/W37.68</b>	<b>A12/W33.30</b>
Date of testing		<b>2024-07-11</b>	<b>2024-07-11</b>	<b>2024-07-11</b>
Transient test procedure	YES / NO	NO	NO	NO
Average defrost time of 1 cycle	[min]	–	–	–
Average time of 1 cycle	[min]	–	–	–
Calculation time	[min]	70.0	70.0	70.0
Output heating water – temperature calculation	[°C]	42.00	37.70	33.30
Input heating water – temperature calculation	[°C]	37.76	33.40	28.82
Output heating water temperature	[°C]	42.00	37.70	33.30
Input heating water temperature	[°C]	37.76	33.40	28.82
Air temperature – dry bulb temperature	[°C]	2.06	6.93	11.86
Air temperature – wet bulb temperature	[°C]	0.98	5.85	10.78
Relative humidity	[%]	82.70	85.85	88.08
Barometric pressure	[kPa]	98.513	98.442	98.433
Ambient temperature	[°C]	1.91	6.88	11.87
Secondary circuit pressure difference	[kPa]	86.992	87.161	87.380
Efficiency of the secondary liquid pump	[-]	0.339	0.340	0.340
Volume flow rate of heating water	[m <sup>3</sup> ·h <sup>-1</sup> ]	1.2702	1.2788	1.2772
Density of heating water	[kg·m <sup>-3</sup> ]	991.5	993.1	994.5
Specific heat capacity of heating water	[kJ·kg <sup>-1</sup> ·K <sup>-1</sup> ]	4.175	4.175	4.175
Voltage	[V]	399.23	399.76	399.91
Total current	[A]	9.68	7.96	7.40
Overall power input	[kW]	1.837	1.478	1.285
Capacity correction of sec. liquid pump	[W]	59.898	60.223	60.275
Power input correction of sec. liquid pump	[W]	90.59	91.18	91.28
Heating capacity – heating water	[kW]	6.202	6.332	6.583
<b>Corrected heating capacity – heating water</b>	<b>[kW]</b>	<b>6.142</b>	<b>6.271</b>	<b>6.523</b>
Uncertainty of corrected heating capacity	[kW]	± 0.125	± 0.126	± 0.126
<b>Effective electric power input</b>	<b>[kW]</b>	<b>1.746</b>	<b>1.386</b>	<b>1.193</b>
<b>COP</b>	<b>[-]</b>	<b>3.518</b>	<b>4.523</b>	<b>5.466</b>
Uncertainty of COP	[-]	± 0.072	± 0.092	± 0.107
<b>Control settings</b>	<b>[Hz]</b>	<b>25</b>	<b>25</b>	<b>25</b>
Circulation pump settings – heating water	[%]	100	100	100



Temperature level		Medium (reference water temperature 55 °C)	
Reference heating season		„A“ = average ( $T_{designh} = -10\text{ °C}$ )	
Assessment condition		<b>TOL(E)</b>	<b>A, T<sub>biv</sub>(F)</b>
Specification of the assessment condition		<b>A-10/W55</b>	<b>A-7/W52</b>
Date of testing		<b>2024-07-12</b>	<b>2024-07-11</b>
Transient test procedure	YES / NO	YES	YES
Average defrost time of 1 cycle	[min]	4.4	4.8
Average time of 1 cycle	[min]	120.7	122.8
Calculation time	[min]	120.7	122.8
Output heating water – temperature calculation	[°C]	54.27	51.26
Input heating water – temperature calculation	[°C]	48.10	44.59
Output heating water temperature	[°C]	54.99	52.01
Input heating water temperature	[°C]	48.22	44.68
Air temperature – dry bulb temperature	[°C]	-10.16	-7.00
Air temperature – wet bulb temperature	[°C]	-11.16	-8.04
Relative humidity	[%]	69.56	73.91
Barometric pressure	[kPa]	98.256	98.622
Ambient temperature	[°C]	-10.31	-7.09
Secondary circuit pressure difference	[kPa]	83.253	86.512
Efficiency of the secondary liquid pump	[-]	0.335	0.338
Volume flow rate of heating water	[m <sup>3</sup> ·h <sup>-1</sup> ]	1.2719	1.2701
Density of heating water	[kg·m <sup>-3</sup> ]	986.2	987.6
Specific heat capacity of heating water	[kJ·kg <sup>-1</sup> ·K <sup>-1</sup> ]	4.179	4.178
Voltage	[V]	399.23	399.01
Total current	[A]	20.25	19.78
Overall power input	[kW]	4.333	4.180
Capacity correction of sec. liquid pump	[W]	58.324	59.684
Power input correction of sec. liquid pump	[W]	87.74	90.21
Heating capacity – heating water	[kW]	9.028	9.757
<b>Corrected heating capacity – heating water</b>	<b>[kW]</b>	<b>8.969</b>	<b>9.697</b>
Uncertainty of corrected heating capacity	[kW]	± 0.125	± 0.125
<b>Effective electric power input</b>	<b>[kW]</b>	<b>4.245</b>	<b>4.089</b>
<b>COP</b>	<b>[-]</b>	<b>2.113</b>	<b>2.371</b>
Uncertainty of COP	[-]	± 0.030	± 0.031
<b>Control settings</b>	<b>[Hz]</b>	<b>56</b>	<b>56</b>
Circulation pump settings – heating water	[%]	100	100

**Data for SCOP calculation**

- Medium temperature application (reference water temperature 55 °C)
- Reference heating season „A“ – average

	Outdoor heat exchanger	Indoor heat exchanger	Part load ratio	Part load	DC Declared capacity	COP <sub>d</sub> at declared capacity	C <sub>dh</sub> degradation coefficient	CR	COP <sub>bin</sub> (T <sub>j</sub> )	Eff. power input of compressor off state
	Outdoor air inlet	Outlet water temperature								
	[°C]	[°C]								
<b>A</b>	-7	52.00	88.46	9.70	9.697	2.371	0.900	1.00	2.371	–
<b>B</b>	2	42.00	53.85	5.90	6.142	3.518	0.900	1.00	3.518	–
<b>C</b>	7	37.68	34.62	3.79	6.252	4.523	0.961	0.61	4.412	0.0540
<b>D</b>	12	33.30	15.38	1.69	6.523	5.466	0.955	0.26	4.838	0.0540
<b>TOL (E)</b>	-10	55.00	100.00	10.96	8.969	2.113	0.900	1.00	2.113	–
<b>T<sub>biv</sub> (F)</b>	-7	52.00	88.46	9.70	9.697	2.371	0.900	1.00	2.371	–

**Adaption of water temperature – according to ČSN EN 14825:2023, Annex E**

- Medium temperature application (reference water temperature 55 °C)
- Reference season „A“ – average
- Condition D
- Fixed water flow rate – secondary circuit

General formulas and derivation:

$$\begin{aligned} \dot{t}_{\text{outlet, average}} &= \dot{t}_{\text{inlet, capacity test}} + (\dot{t}_{\text{outlet, capacity test}} - \dot{t}_{\text{inlet, capacity test}}) \cdot \text{CR} && [^{\circ}\text{C}] \\ \dot{t}_{\text{outlet, average}} &= \dot{t}_{\text{inlet, capacity test}} + (\Delta t) \cdot \text{CR} && [^{\circ}\text{C}] \\ \dot{t}_{\text{outlet, average}} &= \dot{t}_{\text{outlet, capacity test}} - \Delta t + \Delta t \cdot \text{CR} && [^{\circ}\text{C}] \\ \dot{t}_{\text{outlet, capacity test}} &= \dot{t}_{\text{outlet, average}} + \Delta t - \Delta t \cdot \text{CR} && [^{\circ}\text{C}] \end{aligned}$$

For fixed flow:

$$\Delta t = \text{Declared capacity} / \text{Declared capacity}_{\text{standard rating conditions A7W55}} \cdot 8$$

$$\text{CR} \cdot \Delta t = \text{Part load} / \text{Declared capacity} \cdot \text{Declared capacity} / \text{Declared capacity}_{\text{standard rating conditions A7W55}} \cdot 8$$

$$\text{CR} \cdot \Delta t = \text{Part load} / \text{Declared capacity}_{\text{standard rating conditions A7W55}} \cdot 8$$

$$\dot{t}_{\text{outlet, capacity test, fixed flow}} = \dot{t}_{\text{outlet, average}} + \text{Declared capacity} / \text{Declared capacity}_{\text{standard rating conditions A7W55}} \cdot 8 - \text{Part load} / \text{Declared capacity}_{\text{standard rating conditions A7W55}} \cdot 8$$

$$\dot{t}_{\text{outlet, capacity test, fixed flow}} = \dot{t}_{\text{outlet, average}} + 8 / \text{Declared capacity}_{\text{standard rating conditions A7W55}} \cdot (\text{Declared capacity} - \text{Part load})$$

Measured data:

$\dot{t}_{\text{outlet, average}}$	30.00	[°C]
Declared capacity	6.523	[kW]
Declared capacity <sub>standard rating condition A7W55</sub>	11.721	[kW]
Part load	1.69	[kW]

**Calculation of water temperature**

$$t_{\text{outlet, capacity test, fixed flow}} = 30 + 8 / 11.721 \cdot (6.523 - 1.690) = \underline{\underline{33.30}} \quad [^{\circ}\text{C}]$$

**Calculation SCOP, SCOP<sub>on</sub>, SCOP<sub>net</sub>**

- Medium temperature application (reference water temperature 55 °C)
- Reference heating season „A“ – average

Bin	Outdoor temp. (dry bulb)	Hours	Part load ratio	Heat load	Capacity of HP	Heat load covered by heat pump	Resistive heat elbu (Tj)	Annual resistive heat	COPbin (Tj)	Annual heating demand	Annual power input including electric back up heating	Net annual heating capacity	Net annual power input without electric back up heating	
j	Tj	hj		Ph(Tj)			elbu(Tj)	hj x elbu(Tj)	COPbin in (Tj)	hj x Ph(Tj)		hj x (Ph(Tj) - elbu(Tj))		
[-]	[°C]	[h]	[%]	[kW]	[kW]	[kW]	[kW]	[kWh]	[-]	[kWh]	[kWh]	[kWh]	[kWh]	
<b>TOL(E)</b>	<b>21</b>	<b>-10</b>	<b>1</b>	<b>100.00</b>	<b>10.96</b>	<b>8.97</b>	<b>8.97</b>	<b>1.99</b>	<b>1.99</b>	<b>2.11</b>	<b>11</b>	<b>6</b>	<b>9</b>	<b>4</b>
	22	-9	25	96.15	10.54	9.21	9.21	1.33	33.22	2.20	264	138	230	105
	23	-8	23	92.31	10.12	9.45	9.45	0.66	15.28	2.29	233	110	217	95
<b>A. Tbiv(F)</b>	<b>24</b>	<b>-7</b>	<b>24</b>	<b>88.46</b>	<b>9.70</b>	<b>9.70</b>	<b>9.70</b>	<b>0.00</b>	<b>0.00</b>	<b>2.37</b>	<b>233</b>	<b>98</b>	<b>233</b>	<b>98</b>
	25	-6	27	84.62	9.28	9.30	9.28	0.00	0.00	2.50	250	100	250	100
	26	-5	68	80.77	8.85	8.91	8.85	0.00	0.00	2.63	602	229	602	229
	27	-4	91	76.92	8.43	8.51	8.43	0.00	0.00	2.75	767	279	767	279
	28	-3	89	73.08	8.01	8.12	8.01	0.00	0.00	2.88	713	247	713	247
	29	-2	165	69.23	7.59	7.72	7.59	0.00	0.00	3.01	1252	416	1252	416
	30	-1	173	65.38	7.17	7.33	7.17	0.00	0.00	3.14	1240	395	1240	395
	31	0	240	61.54	6.75	6.93	6.75	0.00	0.00	3.26	1619	496	1619	496
	32	1	280	57.69	6.32	6.54	6.32	0.00	0.00	3.39	1771	522	1771	522
<b>B</b>	<b>33</b>	<b>2</b>	<b>320</b>	<b>53.85</b>	<b>5.90</b>	<b>6.14</b>	<b>5.90</b>	<b>0.00</b>	<b>0.00</b>	<b>3.52</b>	<b>1889</b>	<b>537</b>	<b>1889</b>	<b>537</b>
	34	3	357	50.00	5.48	6.16	5.48	0.00	0.00	3.70	1957	529	1957	529
	35	4	356	46.15	5.06	6.19	5.06	0.00	0.00	3.88	1801	465	1801	465
	36	5	303	42.31	4.64	6.21	4.64	0.00	0.00	4.05	1405	347	1405	347
	37	6	330	38.46	4.22	6.23	4.22	0.00	0.00	4.23	1391	329	1391	329
<b>C</b>	<b>38</b>	<b>7</b>	<b>326</b>	<b>34.62</b>	<b>3.79</b>	<b>6.25</b>	<b>3.79</b>	<b>0.00</b>	<b>0.00</b>	<b>4.41</b>	<b>1237</b>	<b>280</b>	<b>1237</b>	<b>280</b>
	39	8	348	30.77	3.37	6.31	3.37	0.00	0.00	4.50	1174	261	1174	261
	40	9	335	26.92	2.95	6.36	2.95	0.00	0.00	4.58	989	216	989	216
	41	10	315	23.08	2.53	6.41	2.53	0.00	0.00	4.67	797	171	797	171
	42	11	215	19.23	2.11	6.47	2.11	0.00	0.00	4.75	453	95	453	95
<b>D</b>	<b>43</b>	<b>12</b>	<b>169</b>	<b>15.38</b>	<b>1.69</b>	<b>6.52</b>	<b>1.69</b>	<b>0.00</b>	<b>0.00</b>	<b>4.84</b>	<b>285</b>	<b>59</b>	<b>285</b>	<b>59</b>
	44	13	151	11.54	1.26	6.58	1.26	0.00	0.00	4.92	191	39	191	39
	45	14	105	7.69	0.84	6.63	0.84	0.00	0.00	5.01	89	18	89	18
	46	15	74	3.85	0.42	6.69	0.42	0.00	0.00	5.09	31	6	31	6
	Σ		4910							Σ	22643	6390	22593	6339

SCOP <sub>on</sub>	3.54	SCOP <sub>net</sub>	3.56
		<b>SCOP</b>	<b>3.54</b>

Part load performance diagram

- Medium temperature application (reference water temperature 55 °C)
- Reference heating season „A“ – average

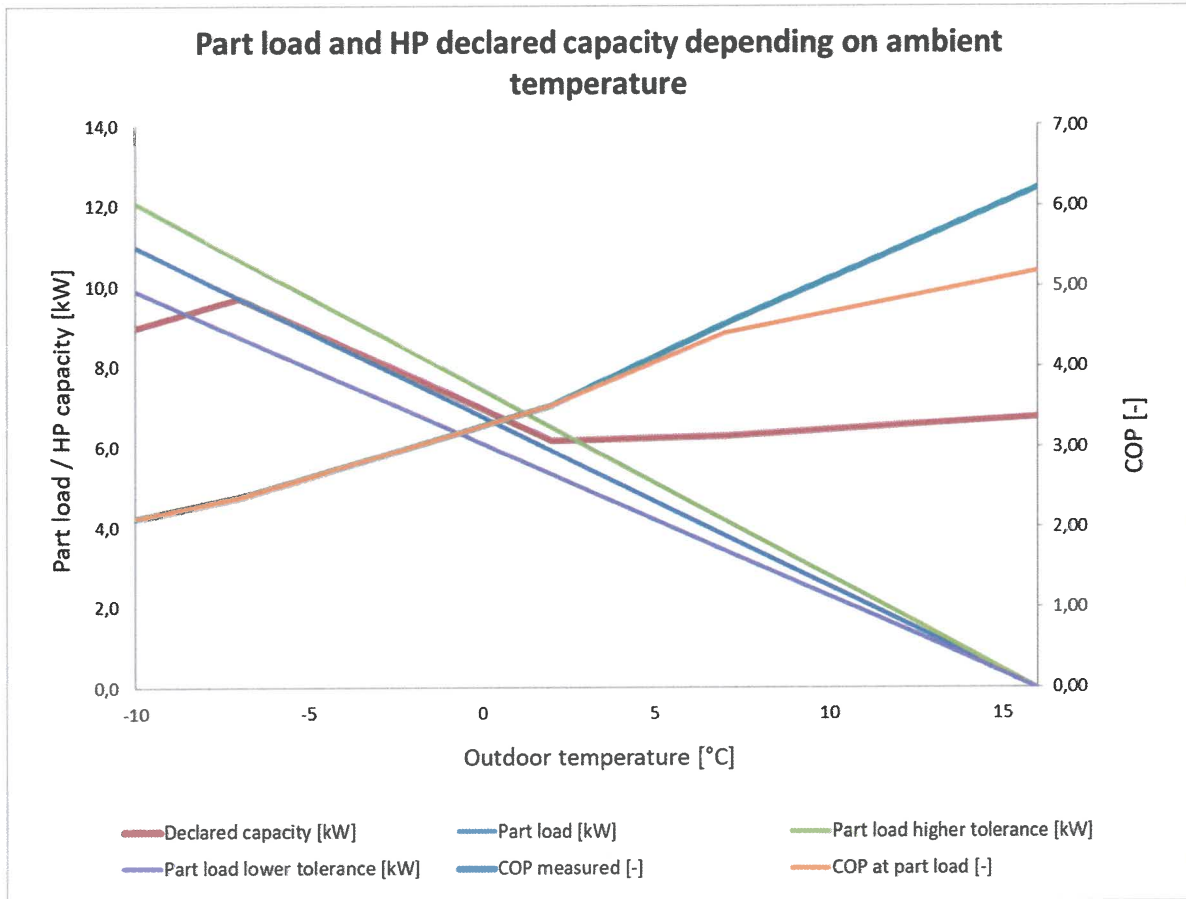

Tested by: Ing. Alexandr Jordanov

Date: 2024-08-18

Signed: 

Reviewed and approved by: Ing. Dominik Šedivý, Ph.D.

Date: 2024-08-18

Signed: 

**V. Graphs**

**1. Rating conditions**

A7W35 (45 Hz, cp 100%)

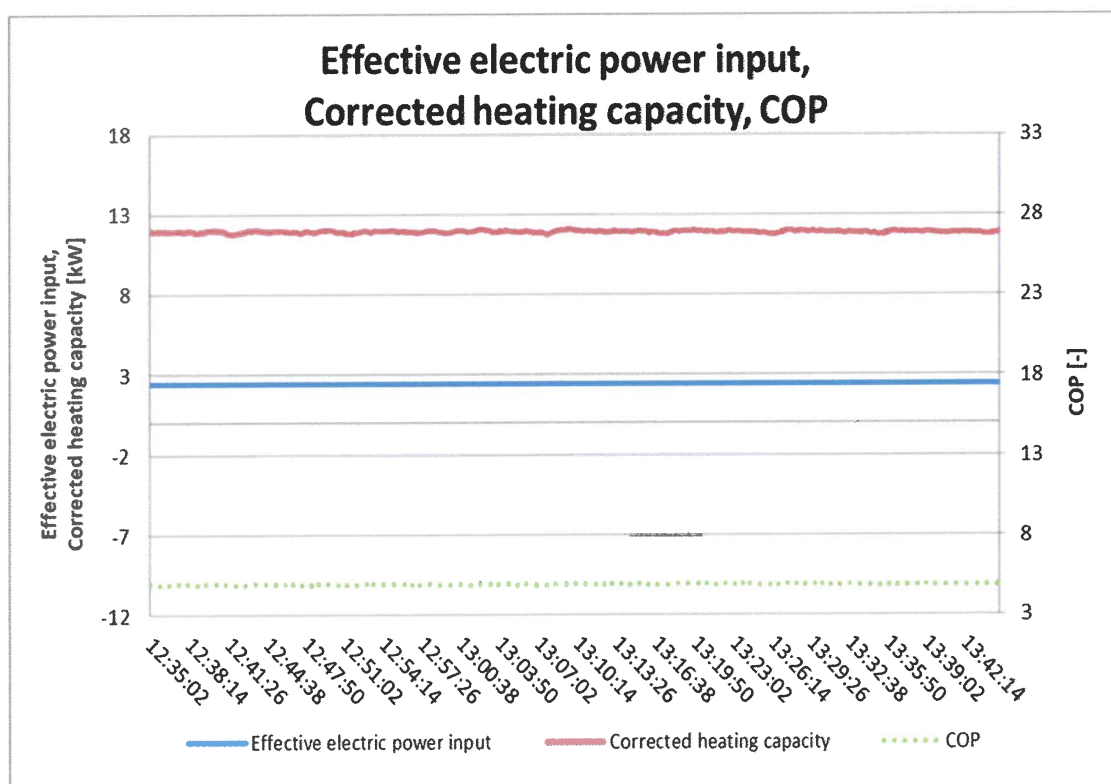
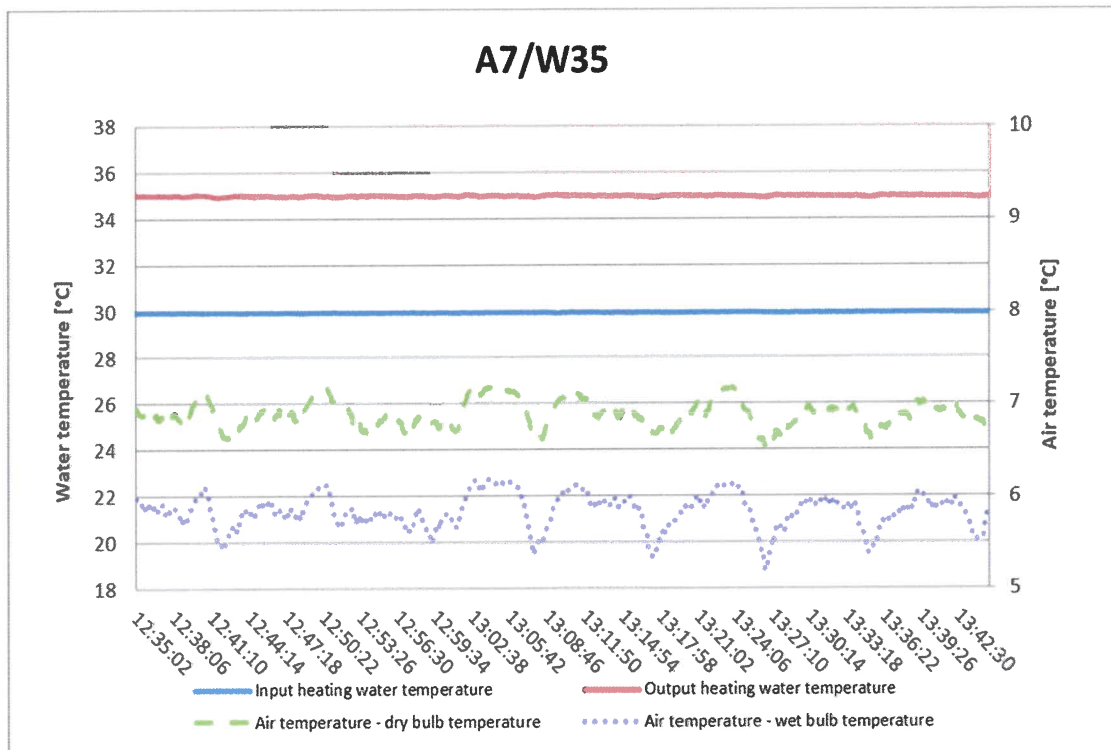

A7W55 (42 Hz, cp 100%)

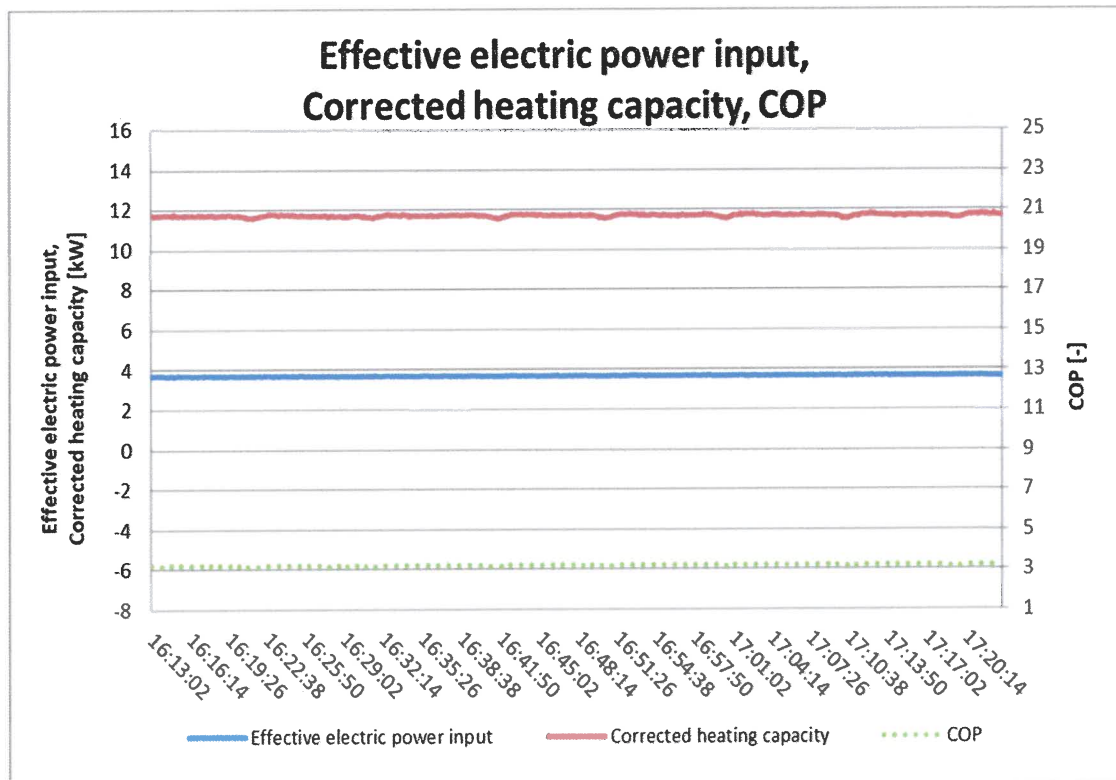
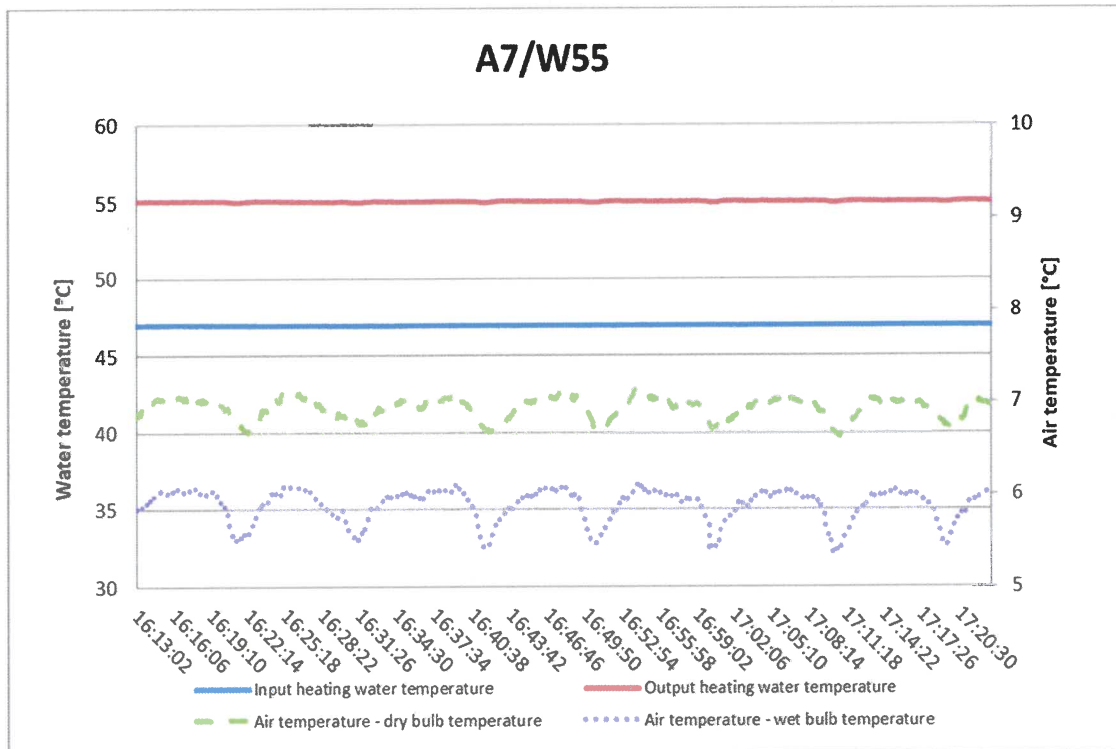

**2. Seasonal performance tests and SCOP calculation – Low temperature application**

A-7W34 (56 Hz, cp 100%)

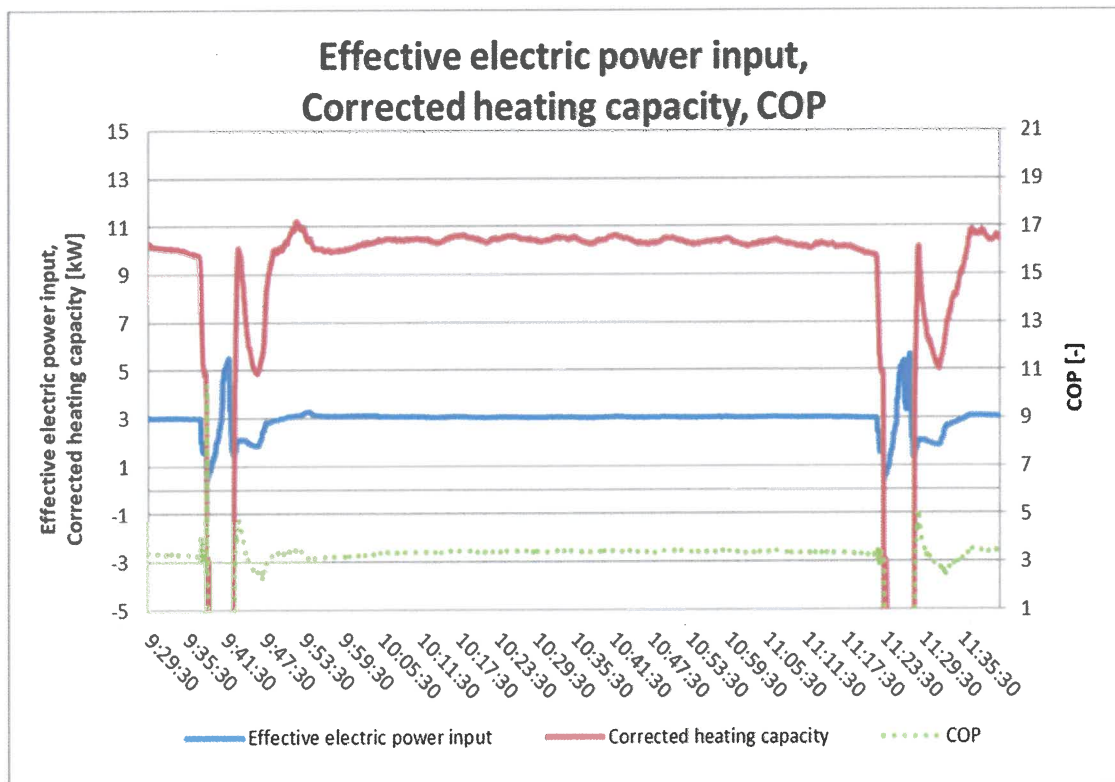
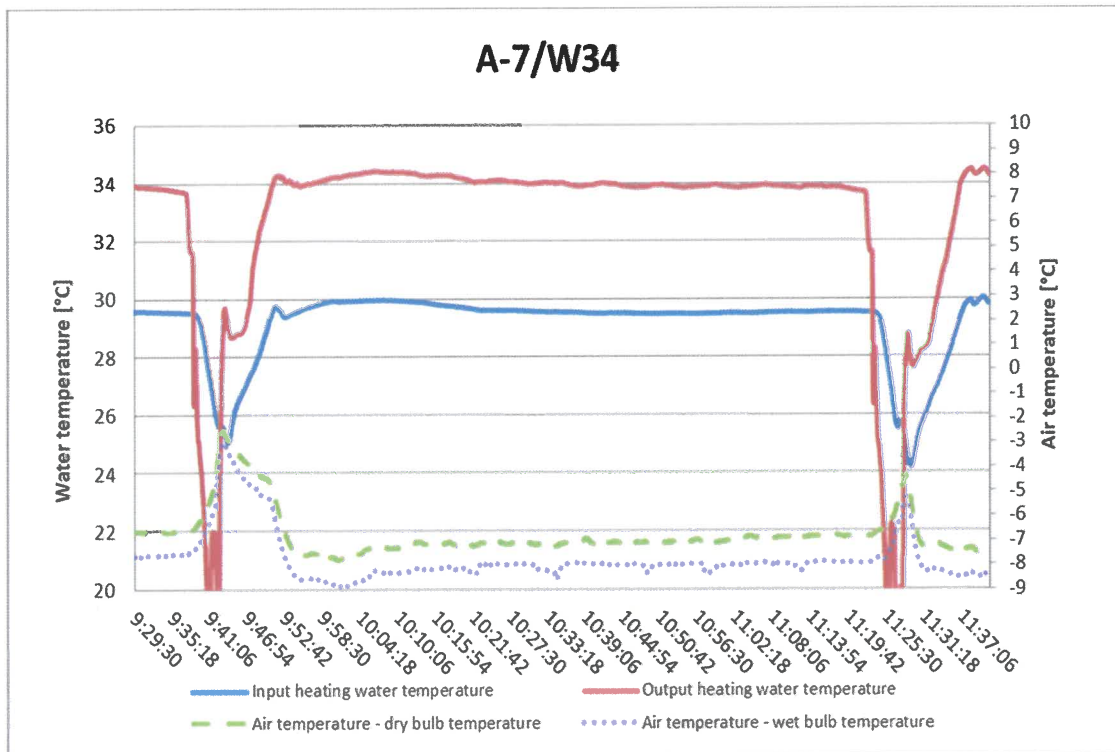

A2W30 (25 Hz, cp 100%)

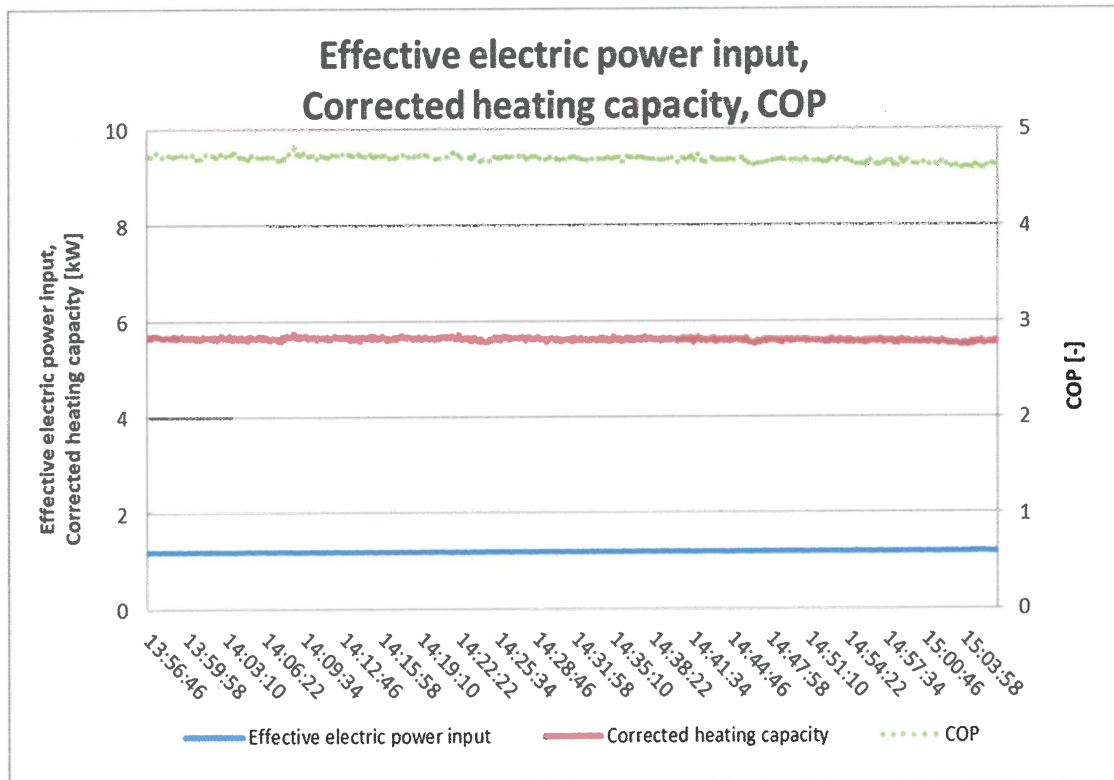
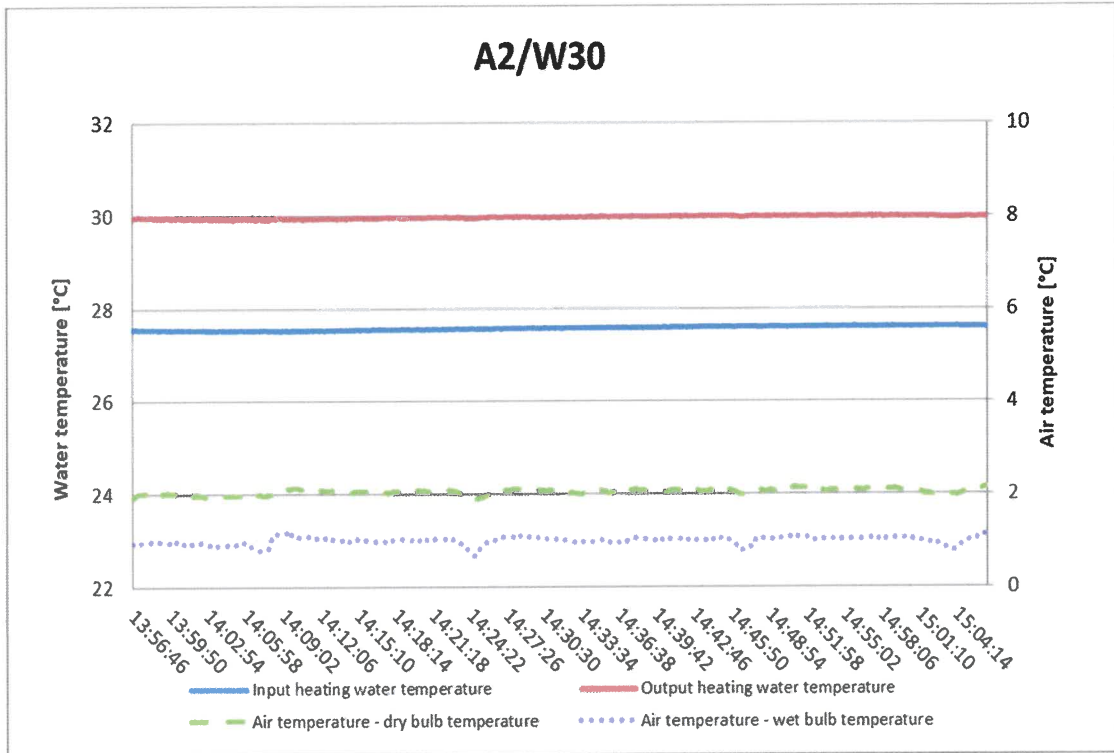



A7W28.24 (25 Hz, cp 100%)

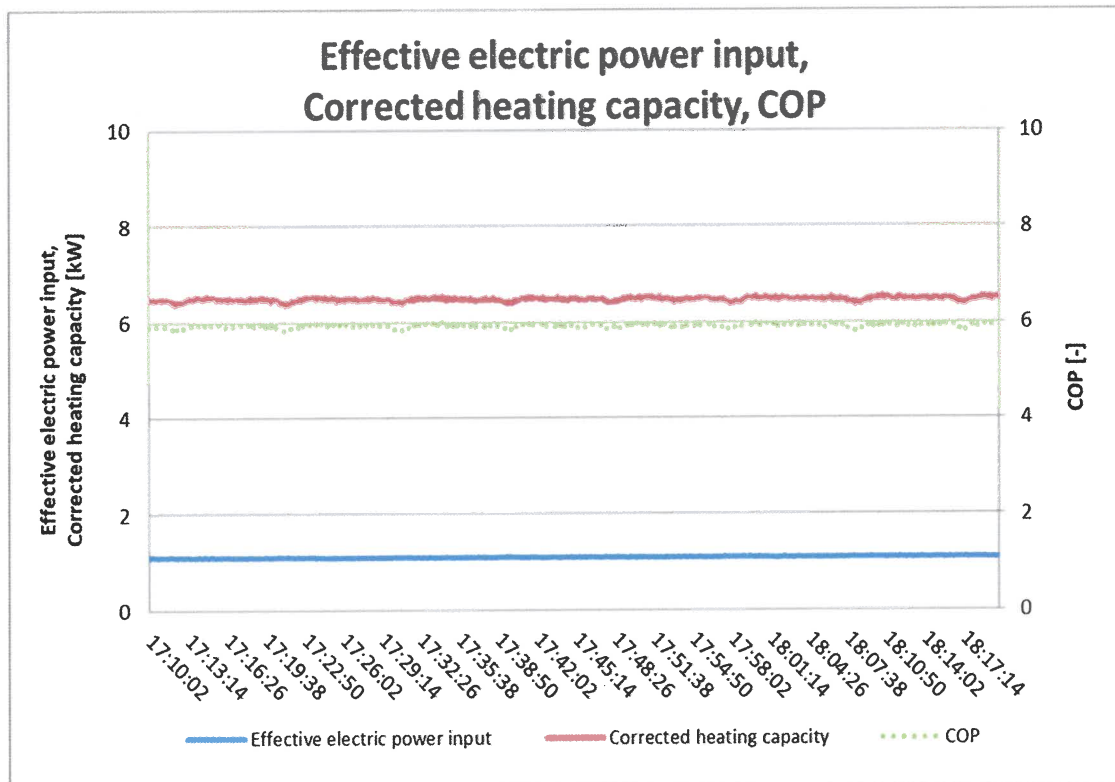
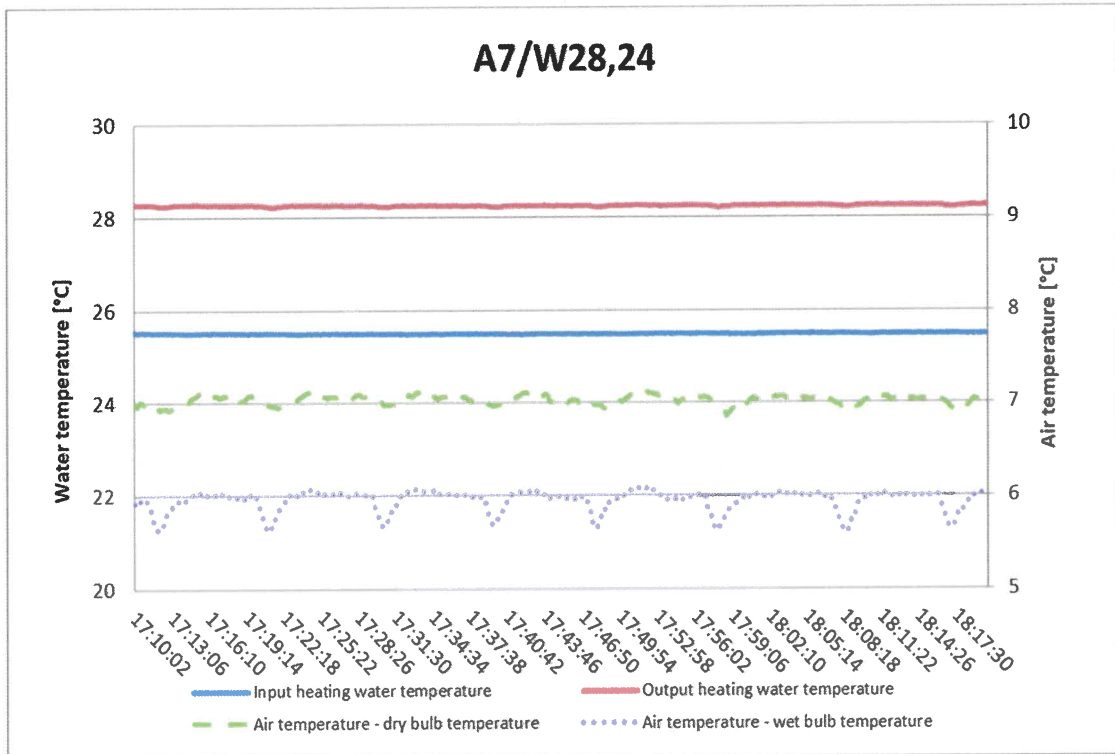

A12W26.48 (25 Hz, cp 100%)

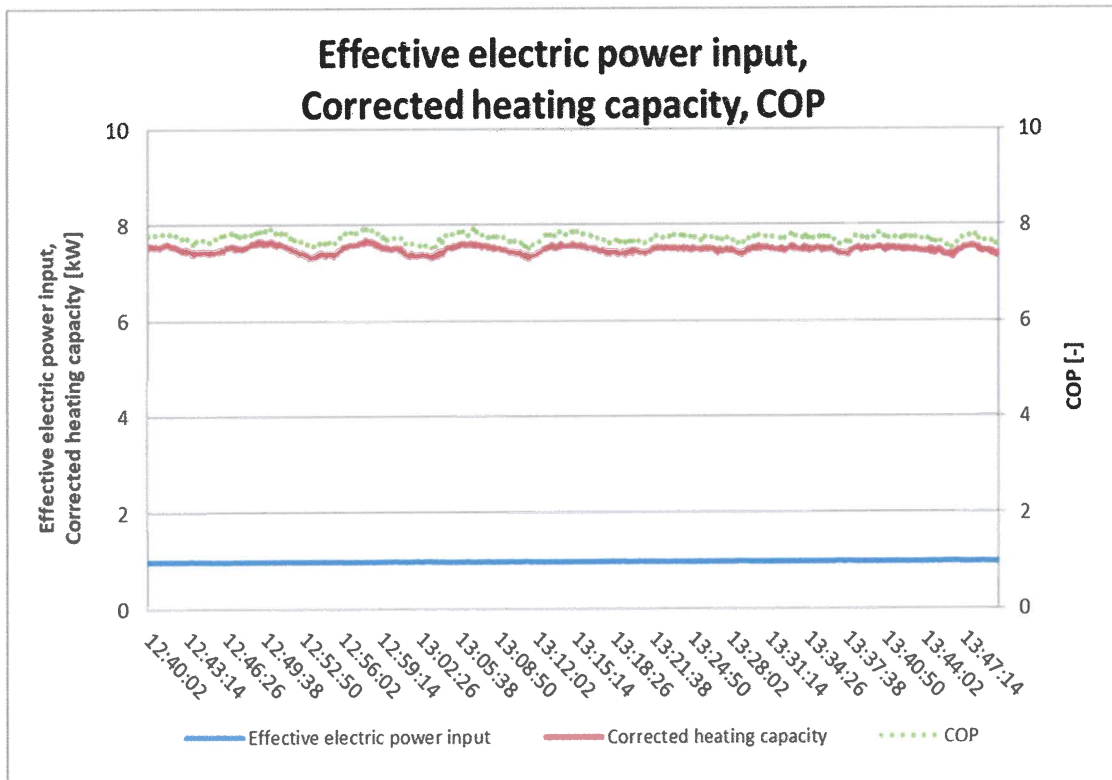
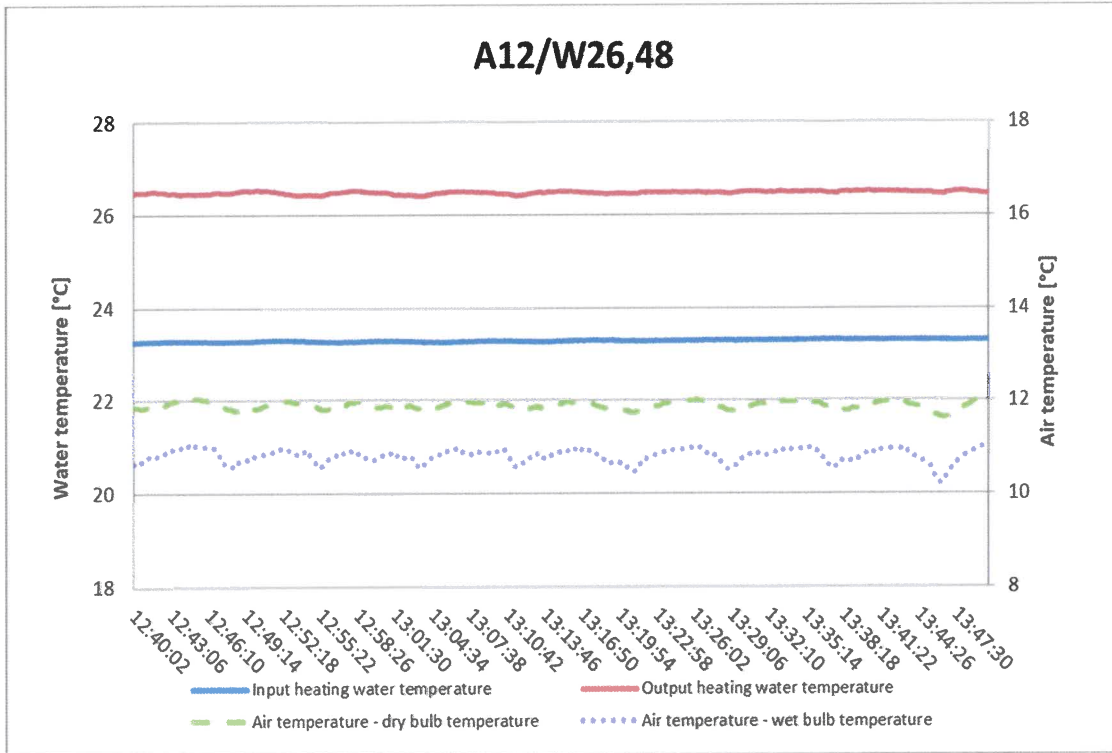

A-10W35 (56 Hz, cp 100%)

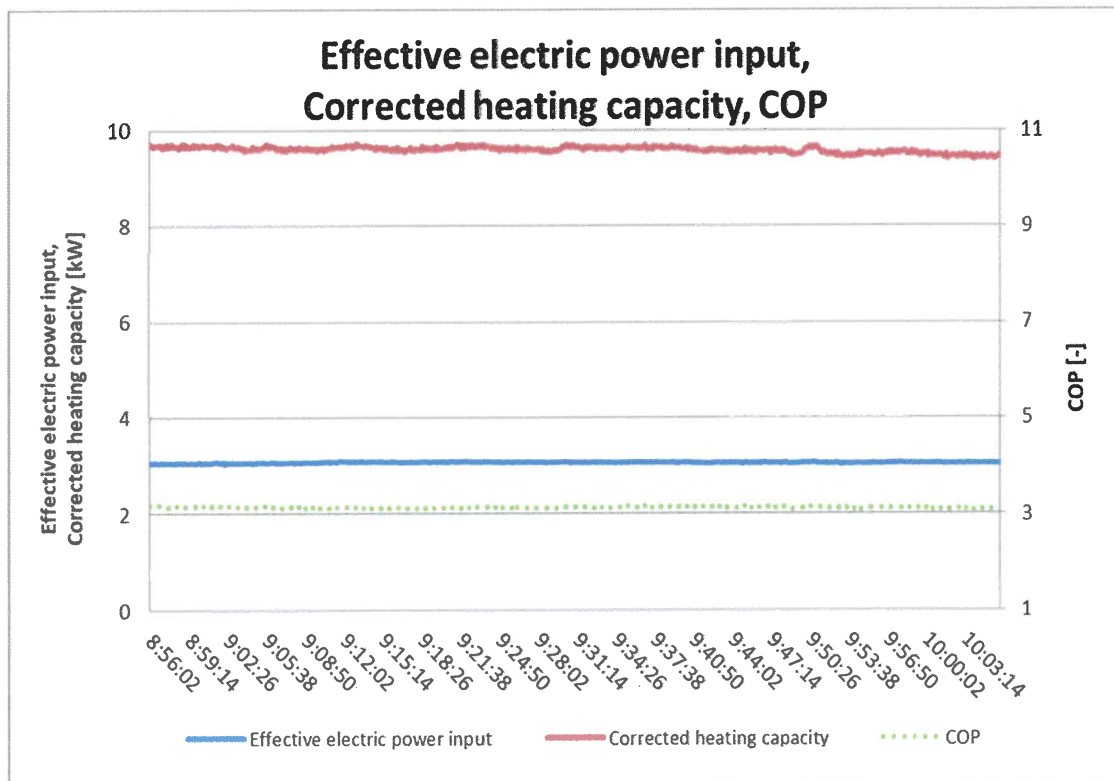
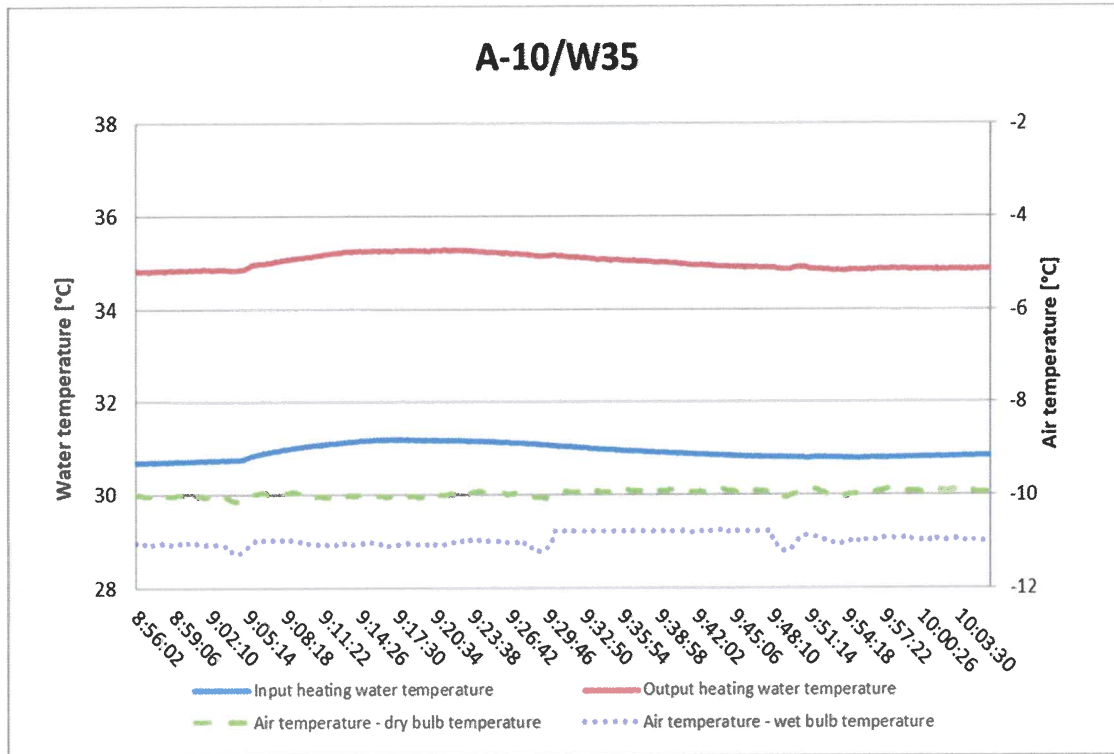

### 3. Seasonal performance tests and SCOP calculation – Medium temperature application

A-7W52 (56 Hz, cp 100%)

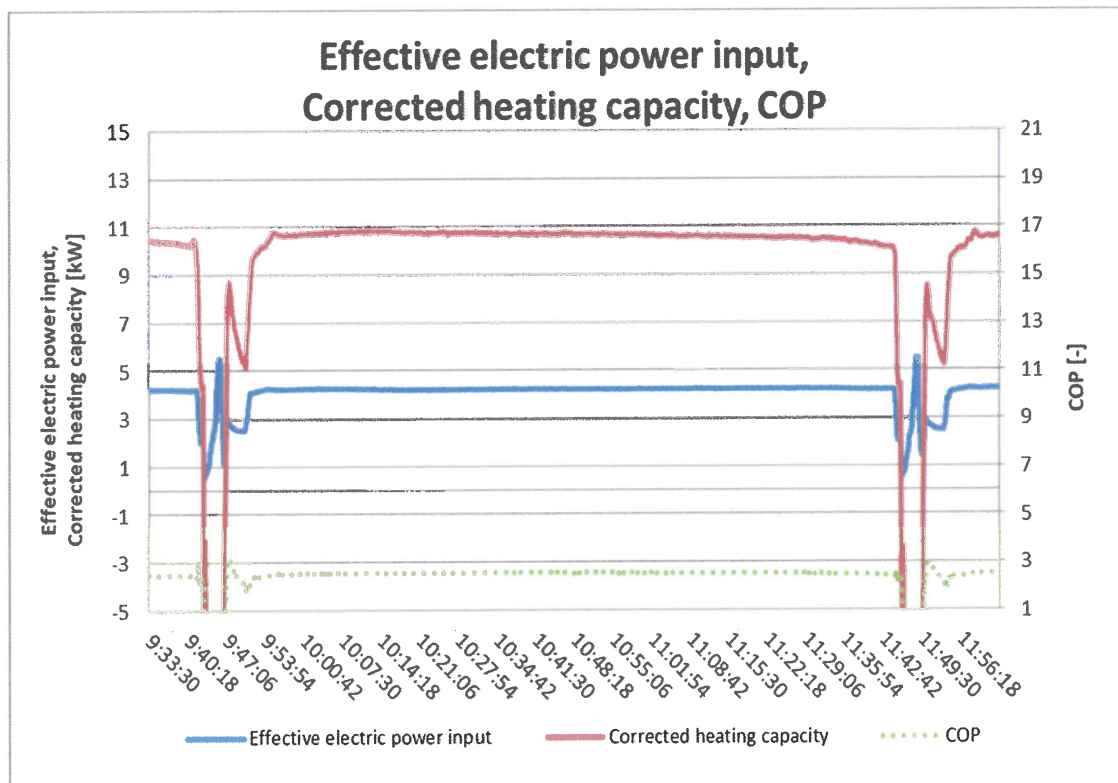
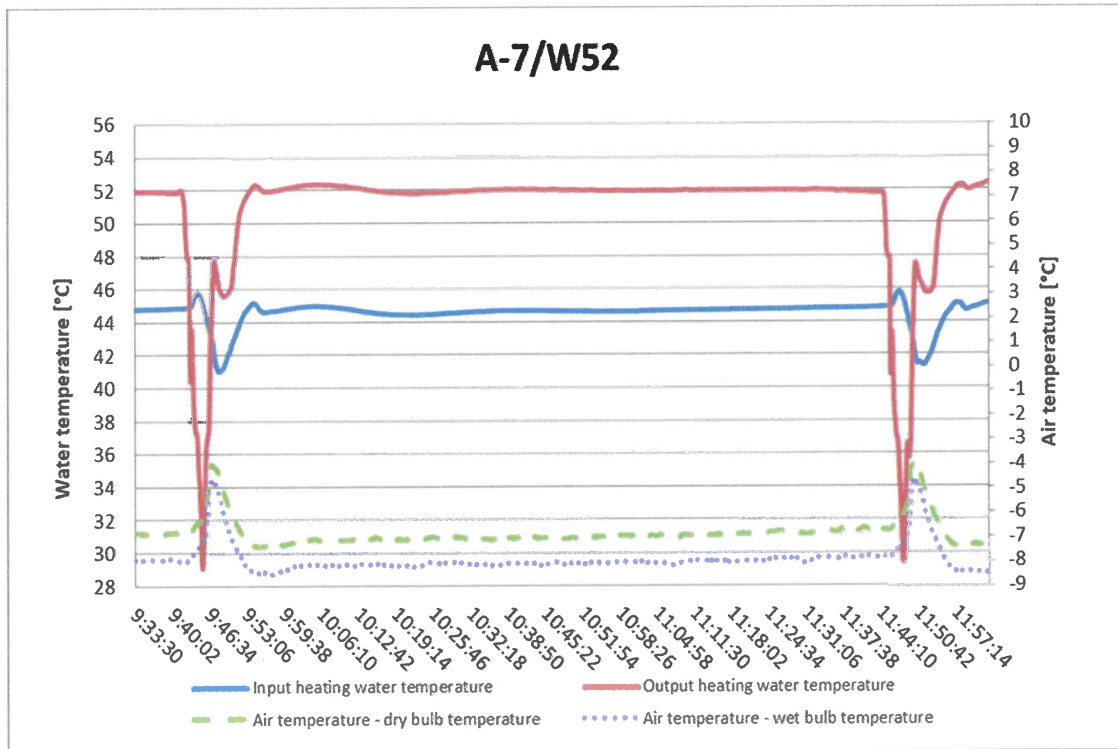

A2W42 (25 Hz, cp 100%)

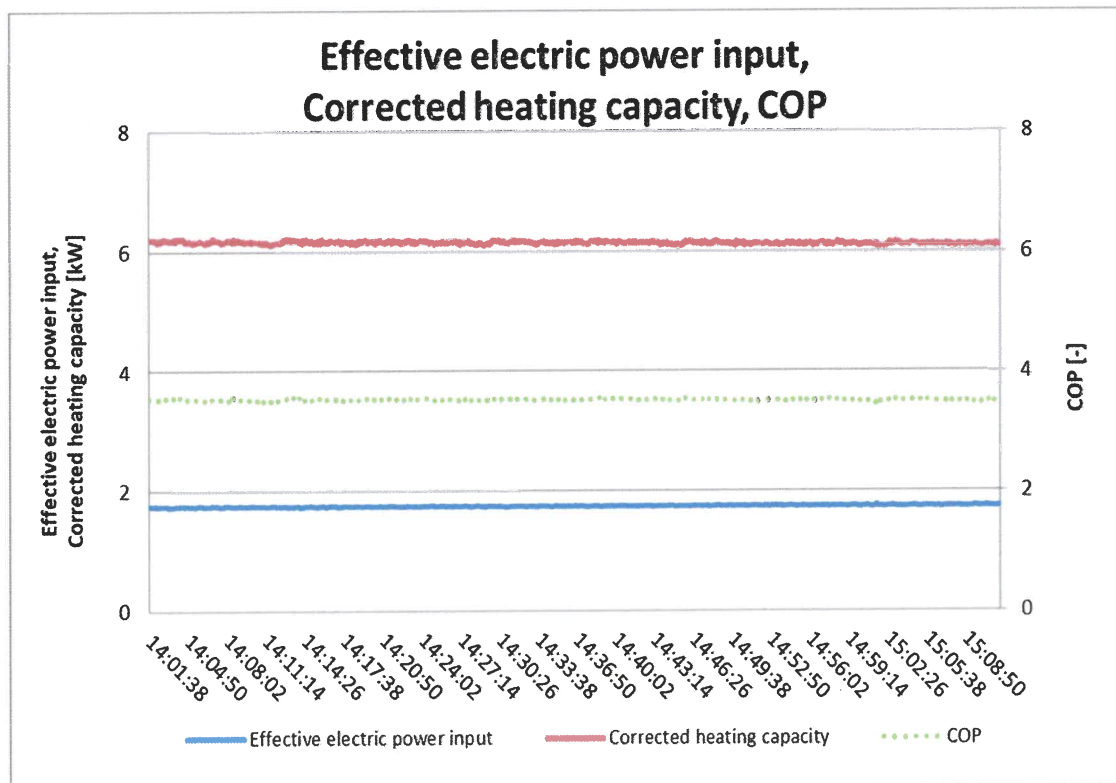
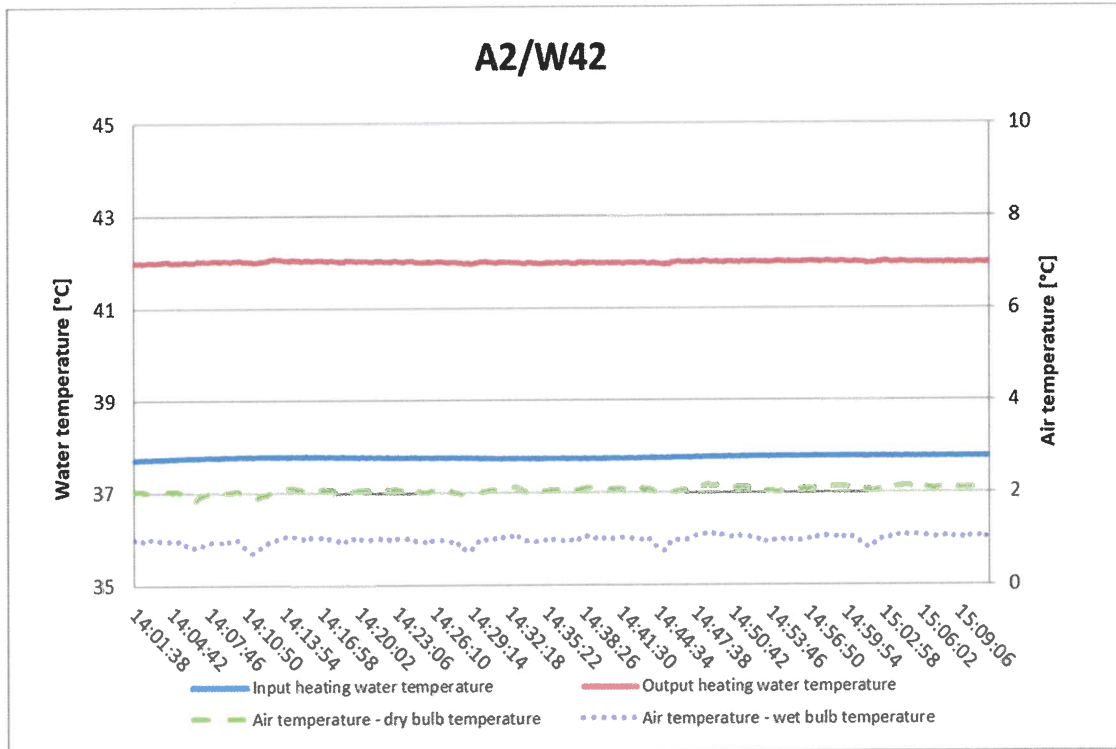

A7W37.68 (25 Hz, cp 100%)

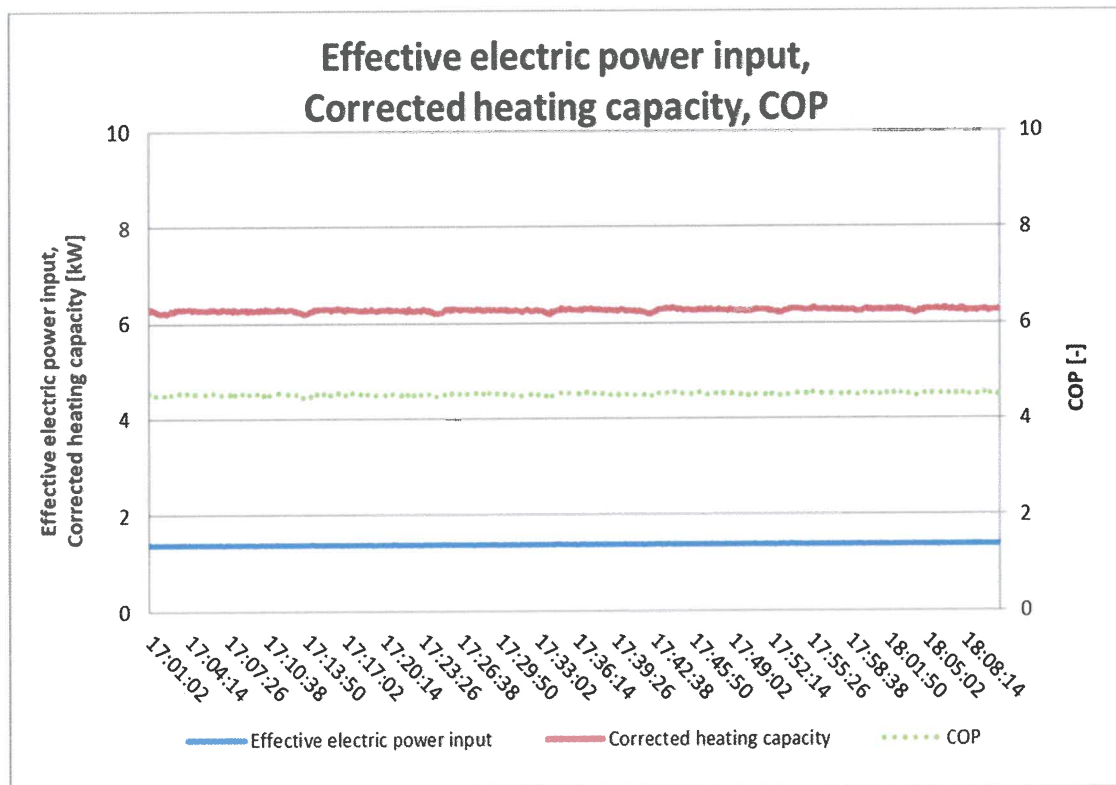
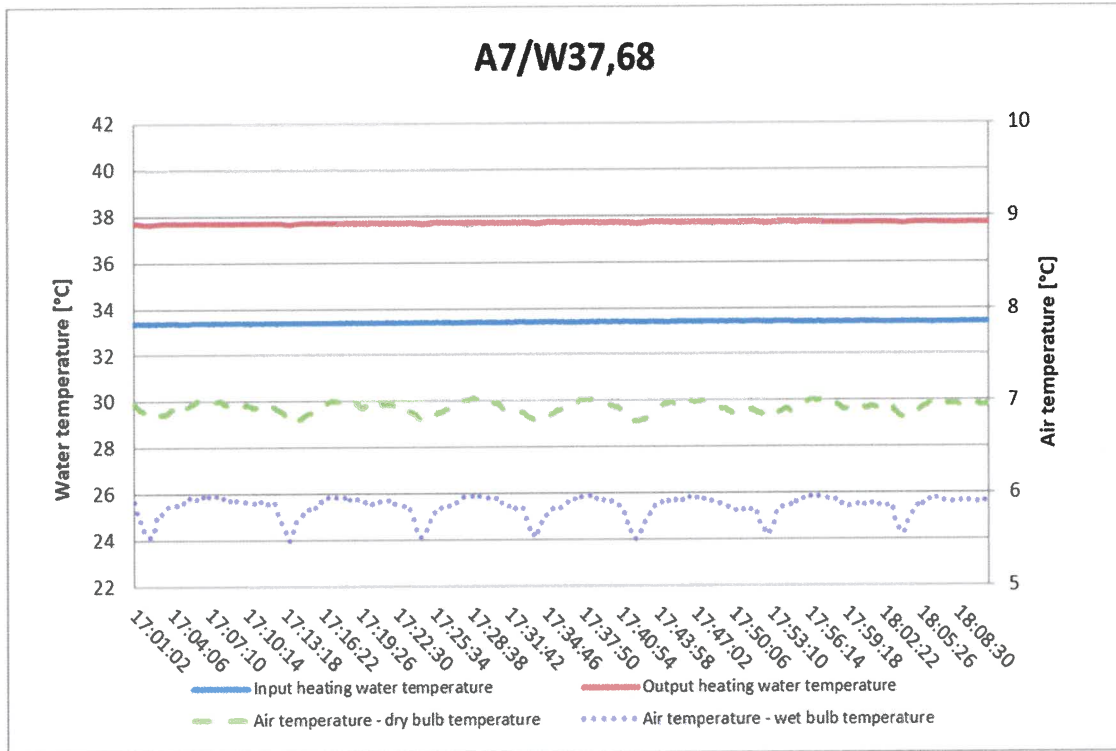

A12W33.30 (25 Hz, cp 100%)

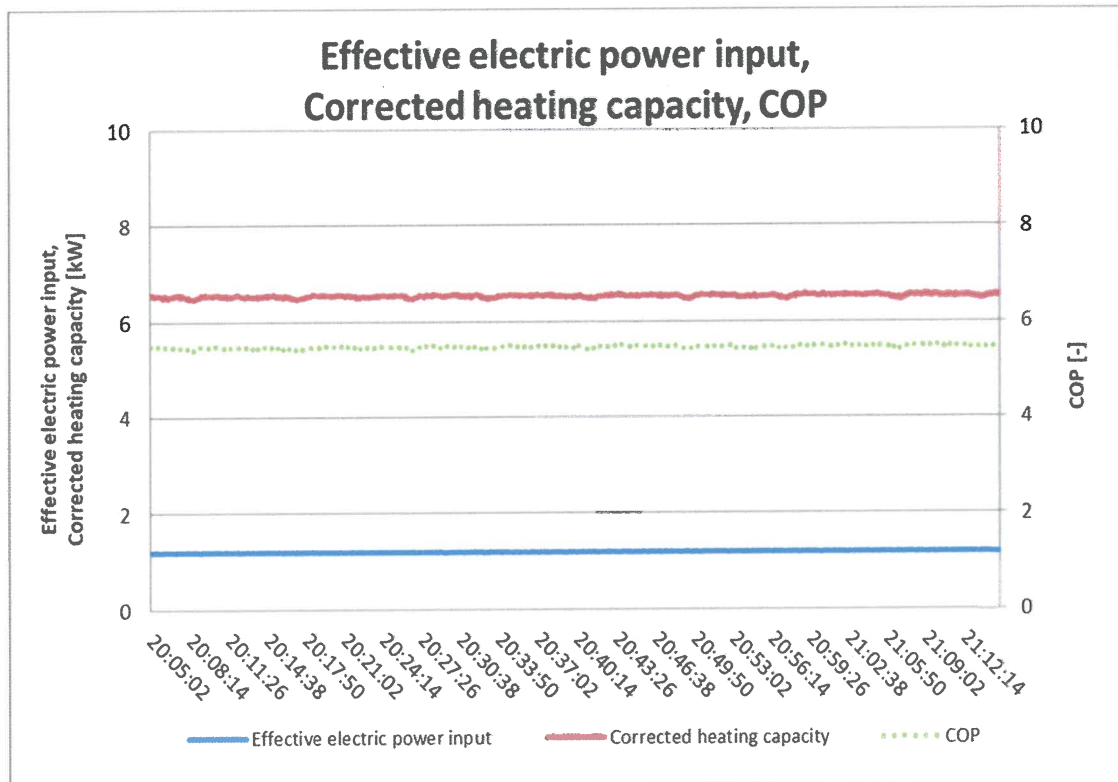
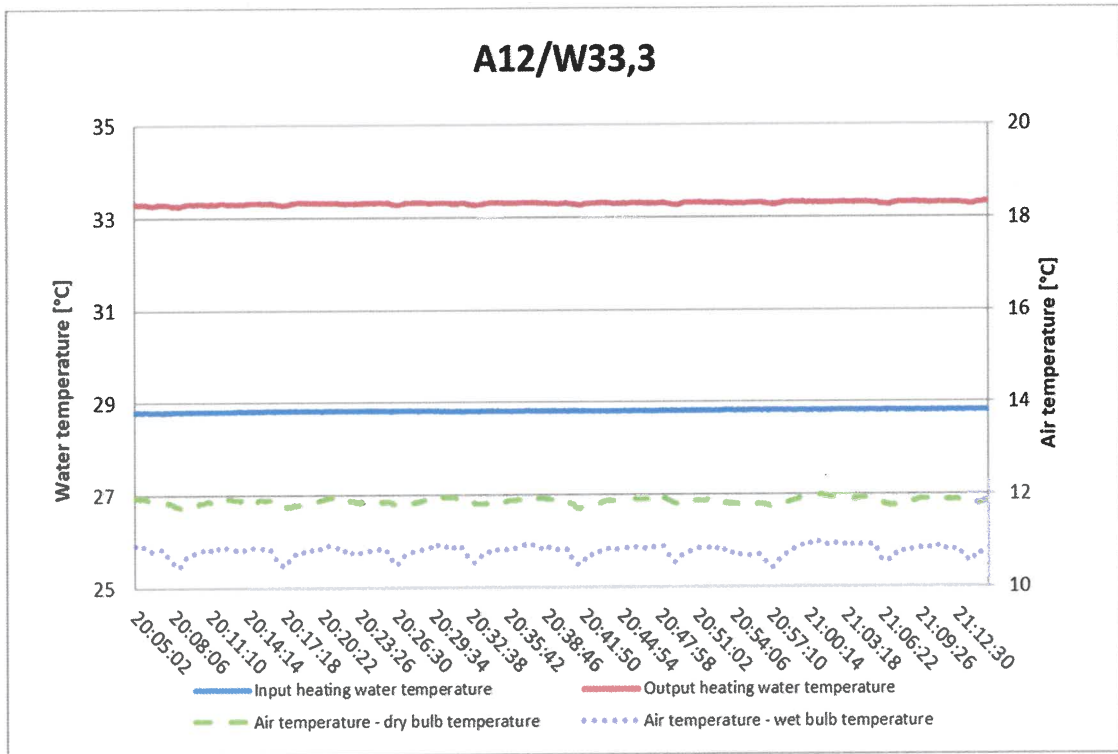

A-10W55 (56 Hz, cp 100%)

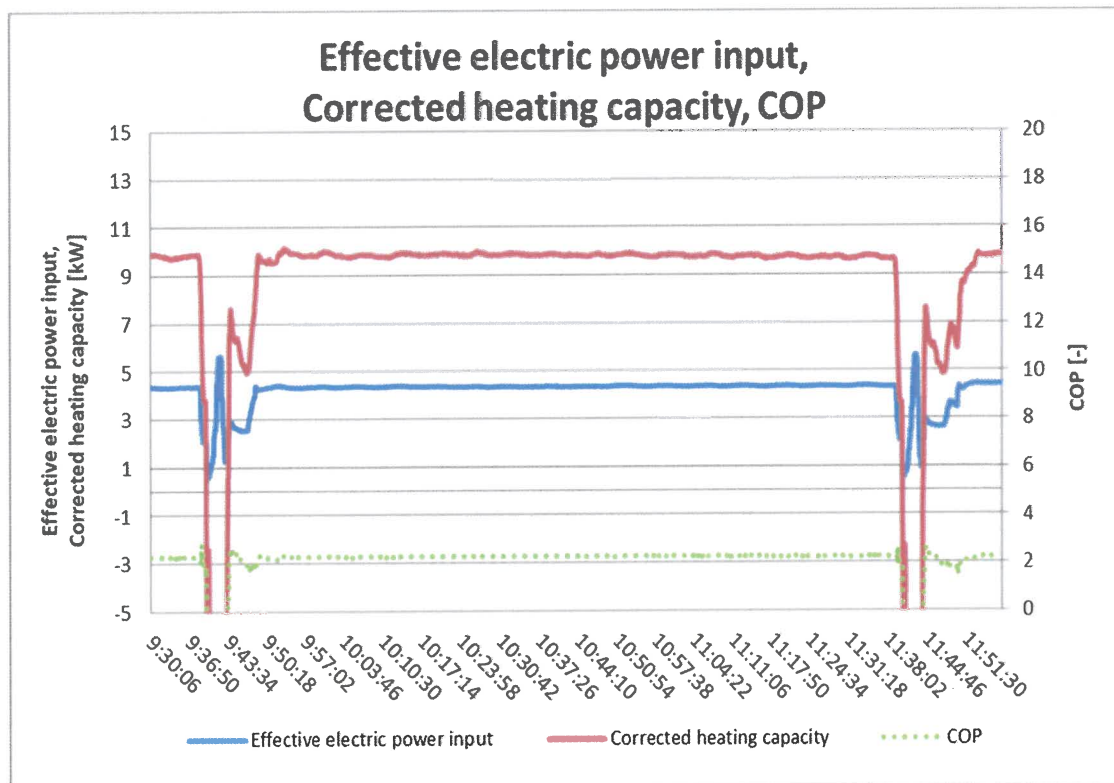
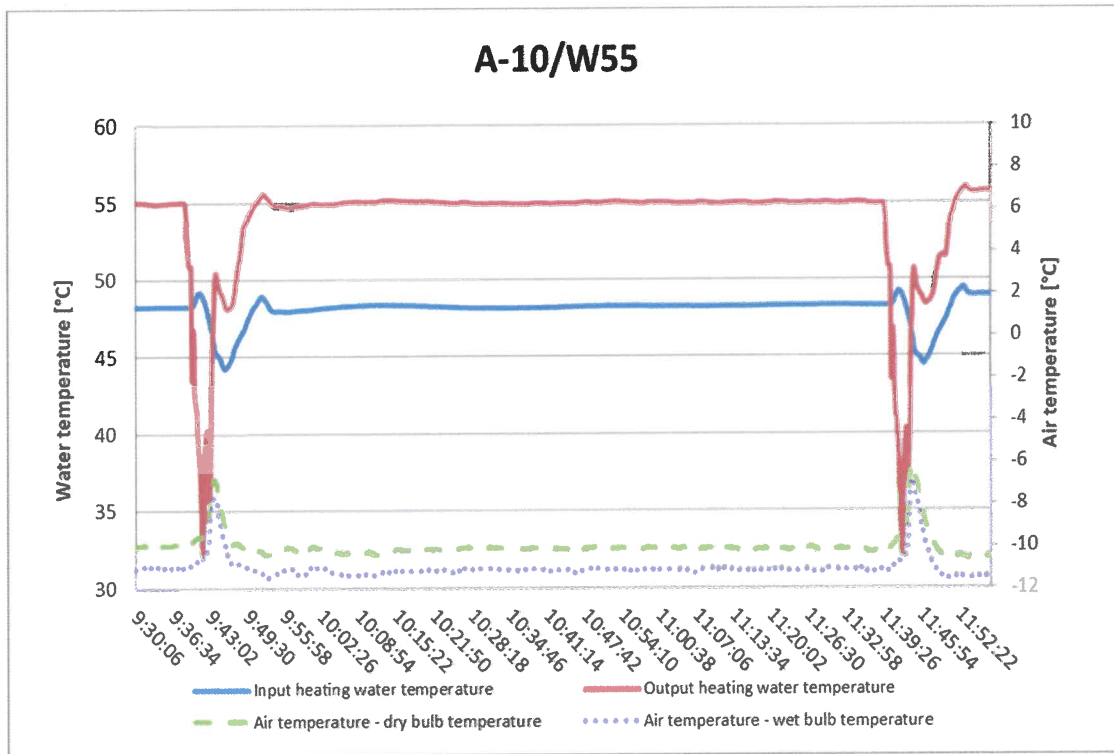



## VI. A list of referenced documents

- Order of 2024-05-16 (Order reg. no. B-82250, received on 2024-05-16)
- Contract B-82250/39
- ČSN EN 14511-2:2023 - Air conditioners, liquid chilling packages and heat pumps for space heating and cooling and process chillers, with electrically driven compressors - Part 2: Test conditions
- ČSN EN 14511-3:2023 - Air conditioners, liquid chilling packages and heat pumps for space heating and cooling and process chillers, with electrically driven compressors - Part 3: Test methods
- ČSN EN 14825:2023 - Air conditioners, liquid chilling packages and heat pumps, with electrically driven compressors, for space heating and cooling, commercial and process cooling - Testing and rating at part load conditions and calculation of seasonal performance

Test Report compiled by:

Ing. Alexandr Jordanov



Test Report approved by:

Ing. Mario Jankola  
Heating Equipment and Construction Products Manager



– End of Test Report –



mgr Jerzy Podgórski  
Tłumacz przysięgły języka angielskiego  
ul. Łabiszyńska 17 m. 84, 03-397 Warszawa  
Tel. (+48 22) 744 00 66 (biuro),  
(+48) 501 211 100

## TŁUMACZENIE Z JĘZYKA ANGIELSKIEGO

[dokument sporządzono na papierze firmowym Engineering Test Institute]  
[dokument posiada nagłówek w języku angielskim i innym języku obcym o następującej treści:]

**Strojirenský zkušební ústav, s.p., Brno, Česká republika**  
**Instytut Badań Technicznych, Przedsiębiorstwo Państwowe, Brno, Republika Czeska**

### CERTYFIKAT BADAŃ

Numer O-B-01390-24

**Klient** Guangdong Tongyi Heat Pump Science and Technology Corp.  
Room 2001-2010, 20/F, No.159 Middle Qiaozhong Road  
510163 Liwan District, Guangzhou  
CHINY

**Produkt** Pompa ciepła powietrze/woda – monoblok

**Oznaczenie typu / znak towarowy** TAHMV12S A

**Metody testowe** ČSN EN 14511-2:2023, ČSN EN 14511-3:2023, ČSN EN 14825:2023;  
ČSN EN 12102-1:2023

**Podstawa certyfikatu** Raporty z badań:  
39-17758/T z 2024-07-18  
39-17758/H z 2024-07-17  
Dokumenty techniczne Guangdong Tongyi Heat Pump Science and  
Technology Corp.

**Referencyjny sezon grzewczy** „A” = średnia  
(Temperatura projektowa odniesienia  $T_{designh} = -10^{\circ}C$ )

### Wyniki:

#### NISKA TEMPERATURA

(Referencyjna temperatura wody 35°C)

#### ŚREDNIA TEMPERATURA

(Referencyjna temperatura wody 55°C)

10,20	$P_{designh}$ [kW] .. Ogrzewanie przy pełnym obciążeniu			10,96	
4,66	SCOP [-]... Współczynnik efektywności sezonowej			3,54	
Temperatura zewnętrzna $T_j$ [°C]	Deklarowana wydajność grzewcza $P_{ah}$ [kW]	Współczynnik efektywności przy deklarowanej wydajności $COP_d$ [-]	Temperatura zewnętrzna $T_j$ [°C]	Deklarowana wydajność grzewcza $P_{ah}$ [kW]	Współczynnik efektywności przy deklarowanej wydajności $COP_d$ [-]
$T_j = -7$	9,020	3,015	$T_j = -7$	9,697	2,371
$T_j = +2$	5,620	4,692	$T_j = +2$	6,142	3,518
$T_j = +7$	6,496	5,925	$T_j = +7$	6,252	4,523
$T_j = +12$	7,490	7,727	$T_j = +12$	6,523	5,466
$T_j = TOL = -10$	9,589	3,127	$T_j = TOL = -10$	8,969	2,113
$T_j = T_{bivalent} = -7$	9,020	3,015	$T_j = T_{bivalent} = -7$	9,697	2,371

[pieczęć okrągła w innym języku obcym o następującej treści:] Strojirenský zkušební ústav, CZ 1  
O-B-01390-24, strona 1 (2)

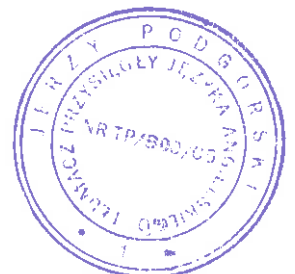



# OŚWIADCZENIE

Guangdong Tongyi Heat Pump Science and  
Technology Corp. oświadcza, iż pompy ciepła

- 1) TAHMV9S A  
Oznaczenie/typ/identyfikator modelu
- 2) TAHMV12S A  
Oznaczenie/typ/identyfikator modelu
- 3) TAHMV14S A  
Oznaczenie/typ/identyfikator modelu
- 4) TAHMV16S A  
Oznaczenie/typ/identyfikator modelu
- 5)   
Oznaczenie/typ/identyfikator modelu

Należą do jednego podtypu w danym typoszeregu i spełniają łącznie następujące warunki:

- identyczna konstrukcja obiegu chłodniczego, ten sam czynnik chłodniczy/roboczy;
- ten sam producent, typ i liczba sprężarek;
- ten sam typ elementu rozprężnego;
- ten sam typ skraplacza;
- ten sam typ parownika;
- ten sam typ procesu odszraniania;
- ten sam sterownik i zasada sterowania wydajnością;
- ten sam producent, typ i liczba wentylatorów parownika (w przypadku powietrznych pomp ciepła) i zasada sterowania wydajnością (stała, zmienna lub stopniowana regulacja prędkości obrotowej);
- urządzenia z i bez zaworu czterodrogowego nie mogą być zaliczone do tego samego typoszeregu.

Guangzhou 2024.9.4

Miejscowość, data

  
Podpis osoby upoważnionej

